

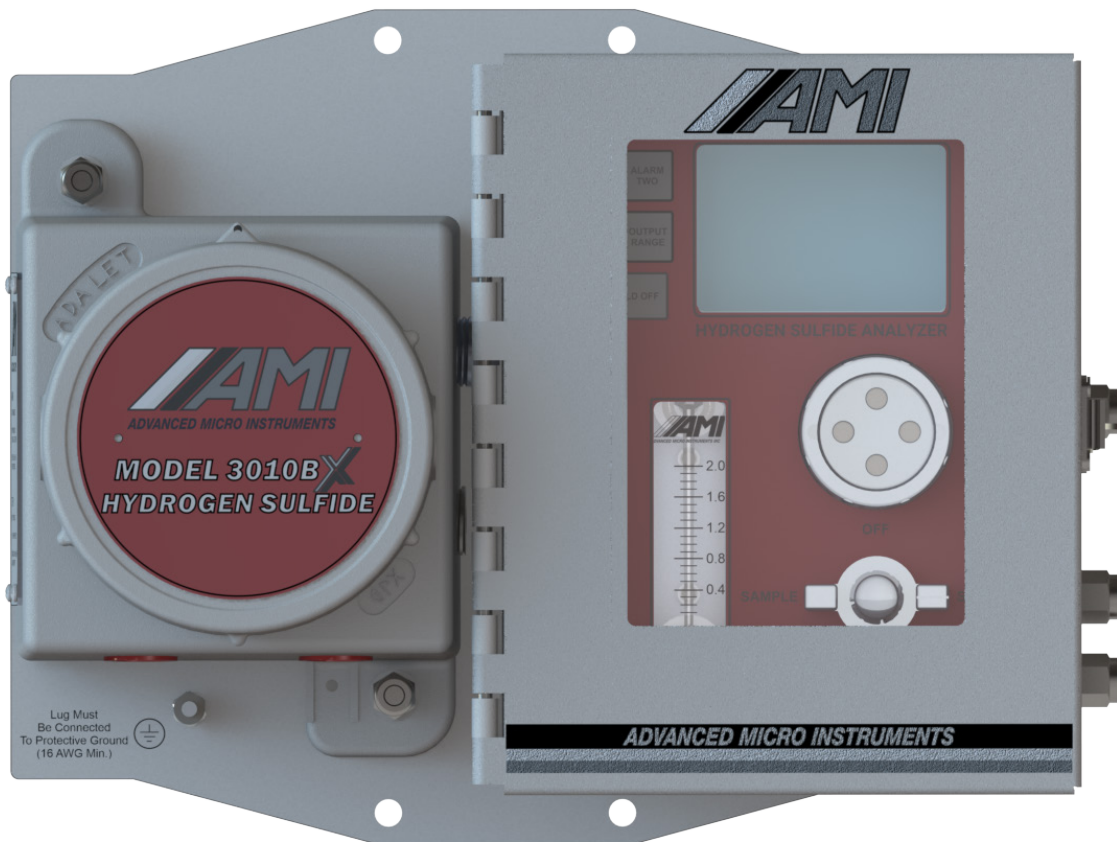

MODEL 3010B^X TRACE HYDROGEN SULFIDE ANALYZER



Operator Manual

MODEL 3010B OPERATOR MANUAL

Special Message from Advanced Micro Instruments (AMI):

Thank you for purchasing this **MODEL 3010BX** for your Trace Hydrogen Sulfide measurement needs. This permanent mount Trace Hydrogen Sulfide Analyzer is the industry's most advanced and contains patented designs and innovations. You will find that it delivers the highest levels of performance and reliability with a full suite of standard features.

Note: Read this manual carefully prior to installation.

If you have any questions, contact AMI at 714.848.5533 or www.amio2.com.

TABLE OF CONTENTS

MODEL 3010BX Overview	2
Method of Measurement	3
Key Innovations	4
Safety, Warnings & Cautions	5
Analyzer Installation	8
Part I: Mounting the Analyzer	8
Part II: Electrical Connections for the Analyzer	9
Initiation of the Pressure Sensor	15
Part III: Gas Connections	16
Initiation of Sample Flow	19
Sensor Installation / Replacement	20
Calibration	22
Analyzer Operation	24
Changing Display to Metric Units	27
COMMAND CENTER Interface Software Set-up	30
Remove the Explosion-proof Cover	30
Establish a Communication Link	30
Analyzer Output Setup	32
Alarm Setup	35
Controls Both Alarms Setup	37
Datalog Column Setup	38
Download Data	39
Modbus RS485 Communication Protocol	42
Troubleshooting, Maintenance & Repairs	46
Specifications	50
AMI® Warranty & Support	52
Limited Warranty/Disclaimer	52
Limitation of Liability	52
Limitation of Remedies	52
Approvals	54

ANALYZER OVERVIEW

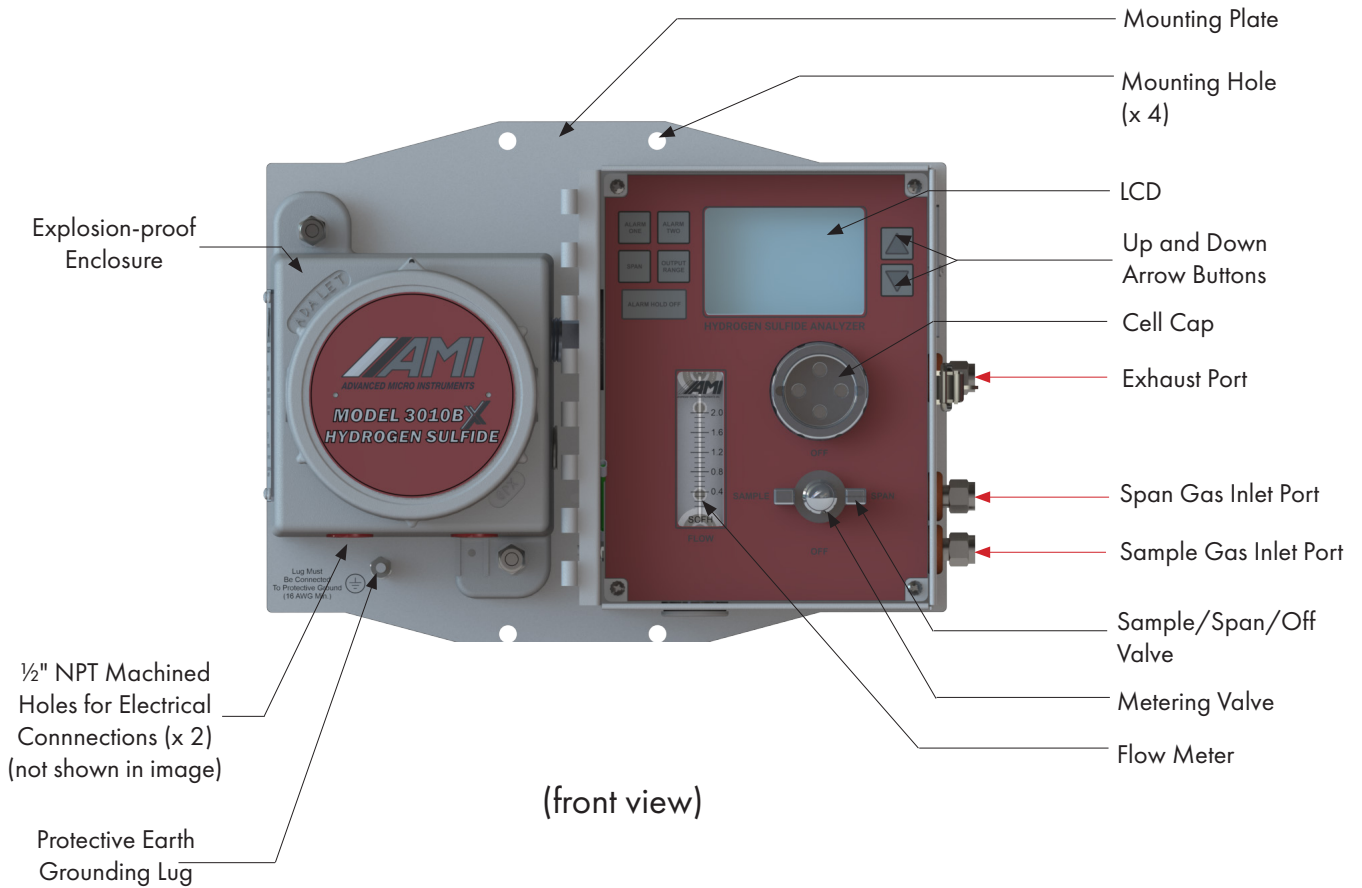

CAUTION
Gas may be hazardous.

Case Earth Ground Lug
(Note: No Customer Connections)

Warning/Caution Information Plate

METHOD OF MEASUREMENT: ELECTROCHEMICAL HYDROGEN SULFIDE SENSORS

The **MODEL 3010BX** utilizes an electrochemical sensor with a strong sensitivity to trace levels of hydrogen sulfide. AMI offers customers two sensor options, based on the needs of their applications. One option can measure trace hydrogen sulfide levels to as high as 200 ppm, while the other option increases the measurement range to 2000 ppm.

Hydrogen Sulfide Sensor	Range(s)
Low Range	0 – 10 ppm, 0 – 50 ppm, 0 – 100 ppm, 0 – 200 ppm
High Range	0 – 100 ppm, 0 – 500 ppm, 0 – 1000 ppm, 0 – 2000 ppm,

IMPORTANT:

The Analyzer measurement configuration is SPECIFIC to the H₂S Sensor it uses. The low-range sensor can only be used with the MODEL 3010BX low-range configuration, and the high-range sensor can only be used with the MODEL 3010BX high-range configuration. They cannot be interchanged for proper operation.

While our sensors have a strong sensitivity to trace levels of H₂S, they also have a cross-sensitivity to other gases.

Table: Cross-sensitivity of Interfering Gases

Interfering Gas Compound	Symbol	Tested Concentration Input	Tested Level	Low Range Sensor % Effect	High Range Sensor % Effect	4SEN26% Effect
Methyl Mercaptan	CH ₄ S	PPM	40	< 60	< 60	< 55
Hydrogen	H ₂	PPM	400	< 0.5	< 0.2	< 0.2
Carbon Monoxide	CO	PPM	400	< 3	< 4	< 2
Sulfur Dioxide	SO ₂	PPM	20	< 18	< 20	< 20
Nitrogen Dioxide	NO ₂	PPM	10	< -30	< -25	< -20
Chlorine	Cl ₂	PPM	10	< -25	< -12	-5 to +4
Nitrogen Oxide	NO	PPM	50	< 35	< 10	< 0.1
Ethylene	C ₂ H ₄	PPM	400	< 0.5	< 0.25	< 0.1
Ammonia	NH ₃	PPM	400	< 0.1	< 0.1	N/A
Carbon Dioxide	CO ₂	%	5	< 0.1	N/A	N/A
Hydrogen Cyanide	HCN	PPM	10	N/A	N/A	< -14
Hydrogen Chloride	HCl	PPM	5	N/A	N/A	< -0.1

To calculate the effect of the interfering gas on the output of the analyzer, the percent effect is multiplied by concentration input of the known interfering gas. This value will be the offset of the analyzers reading.

Equation: Analyzer Reading = (known H₂S concentration)PPM + (Known Interfering Gas with concentrations levels noted from tested levels) x (% Effect on sensor)

Example 1: A sample gas contains 20 ppm of H₂S and 10 ppm of Sulfur Dioxide. The sensor used is an AMI low range sensor. The Cross-Sensitivity calculation for SO₂ is 10x 0.18=1.8 ppm. The reading for H₂S on the Analyzer will be 20 ppm + 1.8 ppm = 21.8 ppm.

Example 2: A sample gas contains 4 ppm of H₂S and 50 % of CO₂. The sensor used is an AMI low range sensor. The Cross-Sensitivity calculation for CO₂ is 50x 0.001=0.05 ppm (units are ignored here). The reading for H₂S on the Analyzer will be 4 ppm + 0.05 ppm = 4.1 ppm.

KEY INNOVATIONS

Advanced Micro Instruments has developed and patented key technologies that enable our Analyzers to deliver the highest levels of **PERFORMANCE**, **RELIABILITY** and **EASE-OF-USE**. These technologies are utilized by the **MODEL 3010BX** and are not available on any competitive offering.

ELIMINATOR CELL BLOCK™



Our patented **ELIMINATOR CELL BLOCK™** provides a unique sample system approach that virtually eliminates all potential leak paths while optimizing flow efficiencies. The sample system and flow-efficient sensor pocket are machined directly into a solid metallic block and interconnected with precision-drilled, intersecting gas passages – eliminating the need to use long lengths of tubing and leak-prone compression fittings. Additionally, a special engineered 3-way selector valve, metering valve, pressure sensor and flow meter are all integrated into the machined block.

This approach is far superior than the designs of traditional sample systems that use multiple off-the-shelf components, numerous compression fittings and long lengths of tubing that join everything together. The traditional, outdated approach requires a great deal of space and is prone to leaks.

The Block even provides the user with direct front panel access for installing and replacing sensors, as well as air calibration feature, without the need for disassembly or tools.









COMMAND CENTER INTERFACE SOFTWARE



This powerful software platform comes standard with every **MODEL 3010BX** purchase and provides users with access to a full suite of advanced features, including:

- Settings & logic adjustments for 2-fully independent Alarm Relay Contacts
- Security settings to prevent unauthorized adjustments to the Analyzer via the front panel
- Changing the analog outputs from 4 –20 mA to 1–5 VDC or vice versa
- Datalogger that records measurement readings, temperature of the Cell Block, gas pressure, brown-outs and power voltage over a period of 15 days @1-min intervals (data can be displayed on a graph or in tabular format)
- Error Status Display that alerts users to any error(s) detected by the Analyzer
- Communication with the Analyzer via USB Virtual COMport and Modbus bi-directional RS485 Communication

SYMBOL TABLE

	WARNING - RISK OF DANGER OR HARM TO THE USER or RISK OF DAMAGE TO THE PRODUCT. Consult the operator manual.		RISK OF SHOCK (DC)
	Relay		RISK OF SHOCK (AC)
	Earth Ground		Protective Ground
	DC (Direct Current)		AC (Alternating Current)
	Frame Chassis Terminal		

SAFETY, WARNINGS & CAUTIONS

A **WARNING** identifies conditions or procedures that can be dangerous to the user.

A **CAUTION** identifies conditions or procedures that can cause damage to the Product.

WARNING

Make sure no hazardous gas is present in the area before and during installation.

Violation of the National Electrical Code requirements (especially Article 500 that deals with hazardous areas) may cause a fire or explosion with the potential for serious injury or loss of life.

WARNING

Drilling any holes in the enclosure will violate the safety approval and may create risk of harm.

WARNING

Due to non-conductive surfaces, there exists a POTENTIAL ELECTROSTATIC CHARGING HAZARD.

EN RAISON DE SURFACES NON CONDUCTRICES, IL EXISTE UN RISQUE POTENTIEL DE CHARGE ELECTROSTATIQUE

 **WARNING**

You must follow the National Electrical Code (NEC) in your installation. Consult the NEC Handbook for the correct guidelines and standards.

Class I, Div 1 areas must use rigid conduit with seal-offs.

Class I, Div. 2 areas can use flexible conduit with seal-offs.

The Analyzer has approval for Class I, Division 1, Groups C and D. To comply with these requirements you need to assure the following:

- The Protective Earth Ground Lug on the front lower left of the Analyzer mounting bracket must be connected to the High Quality Protective Earth Ground using a 16-gauge wire. Please refer to the image on page 2 of the front view of the Analyzer for the location of the Protective Earth Ground Lug

 **WARNING**

The following power requirements must be met by the installer of the DC/AC power connections to the Analyzer:

- You must include an electrical disconnect means and a current limiting device, such as a switch and fuse. The disconnect device must be marked as a 'disconnect device' and readily accessible to shut off power to the Analyzer. This will allow the Analyzer to be quickly shut-off in case of an emergency. The disconnect and current limiting device must be housed in an enclosure rated for the area classification. Conduit seals may be required on the enclosure, depending on the area classification.

DC-powered version (non-heated)

Use a 0.25-Amp fuse disconnect.

DC-powered version with heater option

Use a 2.5-Amp fuse disconnect.

DC power supply must be an approved Class 2 or limited energy circuit for DC power as stated.

AC-powered version (non-heated)

Use a 0.20-Amp fuse disconnect.

AC-powered version with heater option

Use a 1-Amp fuse disconnect.

The voltage rating for the AC Analyzer is 100 to 240VAC at 50/60Hz \pm 10%.

AC voltages outside this may cause the Analyzer to malfunction.

 **WARNING**

Enclosure materials contain a light metal content of over 10% Aluminum and pose a potential impact spark ignition hazard. The end user shall carry out a risk assessment prior to installation in an EPL Ga environment and shall only install the equipment where the risk of impact has been considered to be negligible.

Les matériaux de boîtier contiennent une teneur en métaux légers de plus de 10% d'aluminium et constituent un risque potentiel d'inflammation. L'utilisateur final doit procéder à une évaluation des risques avant de l'installer dans un environnement EPL Ga et ne doit installer le matériel que dans les cas où le risque d'impact a été considéré comme négligeable.

 **WARNING**

A SEAL SHALL BE INSTALLED WITHIN 50 mm OF THE ENCLOSURE.

UN SCELEMENT DOIT ETRE INSTALLE A MOINS DE 50 mm DU BOITIER.

 **WARNING**

SUBSTITUTION OF COMPONENTS MAY IMPAIR INTRINSIC SAFETY.

LE REMPLACEMENT DE COMPOSANTS PEUT COMPROMETTRE LA SECURITE INTRINSEQUE.

 **CAUTION**

The voltage rating of the DC Analyzer is 10–24V.

- DC input has to be an approved Class 2 or limited energy circuit for DC power
- Voltages outside this range may cause the Analyzer to malfunction.

The voltage rating of the AC Analyzer is 100 to 240VAC at 50/60Hz with a tolerance of +/- 10%.

- Any AC voltages outside this range may cause the Analyzer to malfunction

Any use of this equipment in a manner not specified in this manual or approved AMI documentation may impair the protection provided by the equipment.

Toute utilisation de cet équipement d'une manière non spécifiée dans ce manuel ou dans la documentation AMI approuvée peut altérer la protection fournie par l'équipement.

ANALYZER INSTALLATION

Part I: Mounting the Analyzer

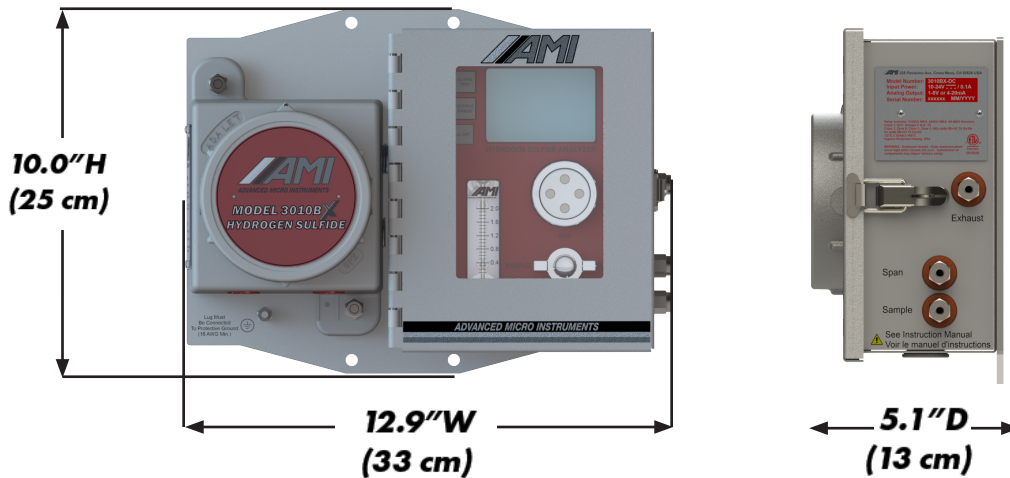

note: Analyzer weighs 16.0 lbs (7.26 kg)

Key Points

- The Analyzer can be mounted either indoors or outdoors, where the ambient temperature remains between 25°F (-3.9°C) and 115°F (46°C)
- For installation, where temperature drops down to -20°F (-29°C), order a **MODEL 3010BX with the factory-installed heater option**
- For installation, where temperature drops down to -40°F (-40°C), order a **MODEL 3010BX with the factory-installed EXTREME WEATHER ENCLOSURE and heater option**
- When using a solar panel to power the Analyzer, we recommend mounting the solar panel just above the Analyzer, using the same mast, to serve as a sunshield



WARNING:

For DC models, do not use above 5,500 m (18,000 ft).

For AC models, do not use above 2,500 m (8,200 ft).



WARNING:

The Analyzer weighs 16.0 lbs (7.26 kg) and can pose a risk to the user if dropped.

STEPS

1. Determine a convenient location to place the Analyzer. The location should ideally be eye-level.
2. Mount the Analyzer to a wall or bulkhead using the 4 mounting holes or to a 2-inch (5 cm) pipe using ¼" x 2" U-brackets with ¼ nuts.

Note: Equipment shall only be installed and operated in the upright orientation with the mounting plate vertical.

Part II: Electrical Connections for the Analyzer

Key Points:

- Verify your rated power supply matches the operating voltage of your Analyzer before you begin
- **THE MODEL 3010BX** is available with either AC or DC Power (you must request your desired power at the time of your purchase)

Note: Refer to page 48 for the power requirements of your Analyzer.

Note: Both alarm relays are rated for 5A @ 115VAC or 24VDC.

- Your Analyzer has both 1–5 VDC and 4–20mA isolated analog signals. It has been setup at the factory per your analog output requirements at the time of purchase. However, this can be easily changed in the field by following the instructions shown on page 31
- Flameproof joints are not intended to be repaired
- Electrical bushing separating the Flameproof and Analytical enclosures shall not be subject to environmental conditions which adversely affect the properties of the cement

STEPS

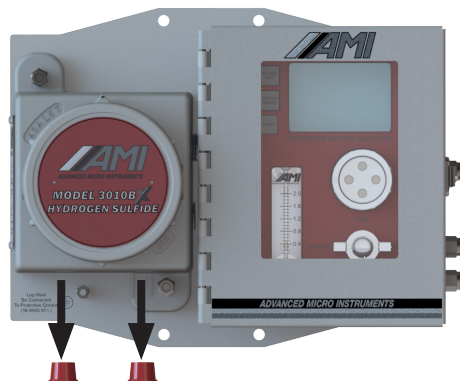

1. Remove the two red plastic protective caps from the ½" NPT conduit holes on the explosion-proof side of the Analyzer. These plastic caps protect the threads of the unit during shipping.
- We provide 2 (two) separate ½" NPT conduit holes to accommodate all electrical connections. The first conduit opening should be used for power and alarm relay connections. The second is for analog output and RS485 connections

Note: AC Power and the opening and closing of alarm relays produce both electrical noise and large inductive spikes that can have an undesirable effect on the measurement readings. This is why we provide two conduit openings and strongly recommend separating the sensitive analog signal wiring from the power and relay wiring.

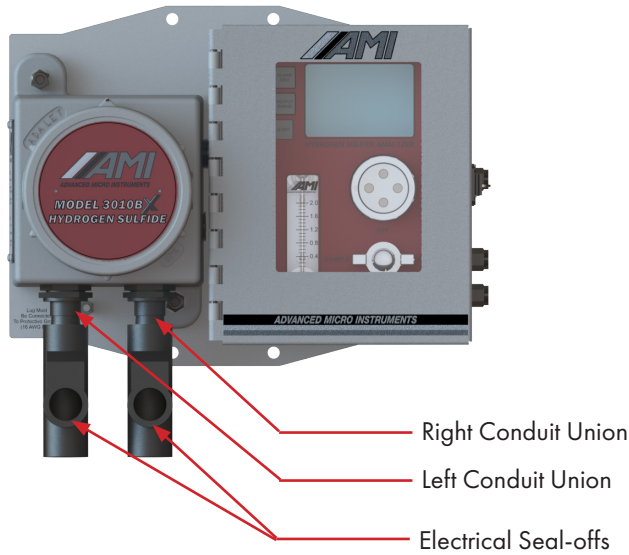

2. Install the conduit unions between the explosion-proof housing of the Analyzer and the electrical seal-off. **DO NOT** fill the electrical seal-offs yet.
- In order to meet electrical codes for Class 1, Div 1 and Class 1, Div 2, Groups C & D, you must use electrical seal-offs in your installation
 - We recommend that you install conduit unions between the explosion-proof housing of the Analyzer and the seal-offs. This will prove very useful in the event that you have to remove the Analyzer for servicing, without cutting wires

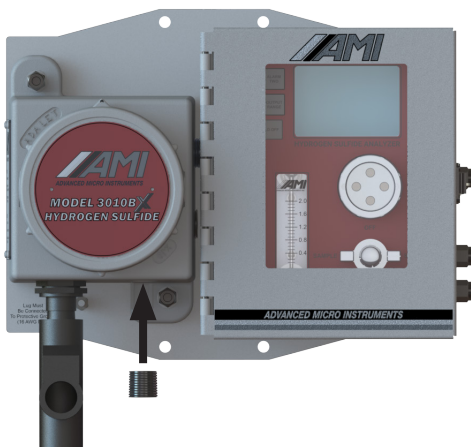

WARNING:

If you are using DC Power and intend on using the analog output only feature (which is the same as using 'NO RELAYS'), you can safely run both DC Power and Analog Output Signal in a single conduit. However, you must install an approved 1/2" NPT plug for hazardous locations in the unused 1/2" NPT port.

FAILURE TO DO SO WILL VIOLATE ALL SAFETY REQUIREMENTS AND POTENTIALLY RESULT IN AN EXPLOSION!

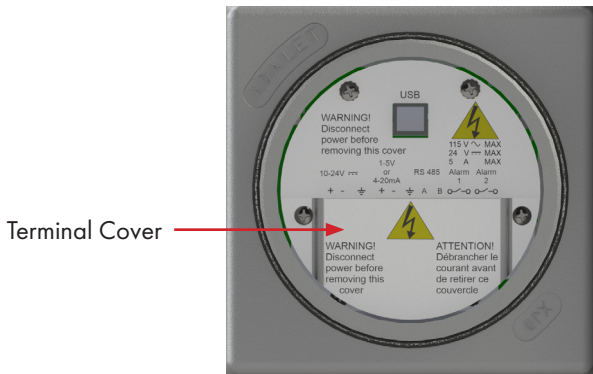

DC Version with Terminal Cover and white information panel

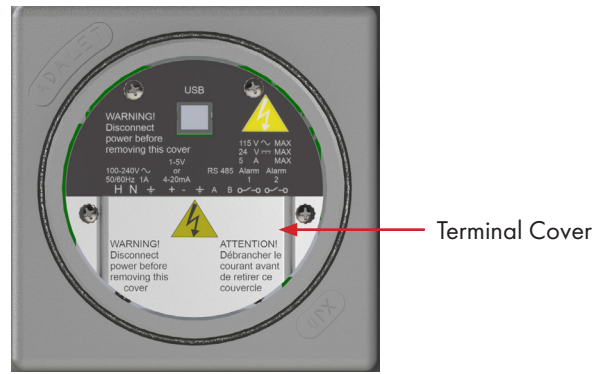

AC Version with Terminal Cover and black information panel

3. Remove the explosion-proof cover by rotating it counterclockwise.

Note: A white sheet metal panel inside the explosion-proof housing indicates DC, while a black sheet metal panel indicates AC power.

4. Then remove the Terminal Cover to access the electrical connections.
5. Verify the operating voltage of your Analyzer and the correct power requirements before you continue.
6. Make sure the power source has been turned-off before you begin installing wiring.



- The green terminal block connectors are combination connectors, which allows you to unplug the connector during the wiring process. Combination connectors can accommodate between 12–24 AWG wire for your electrical connection

IMPORTANT: When attaching wiring to the green terminal connectors, use either solid wire or stranded wire with wire ferrule(s) attached. Verify no loose strands are visible after installation of wire ferrule(s).

1st CONDUIT (POWER & ALARMS):

For DC Power:

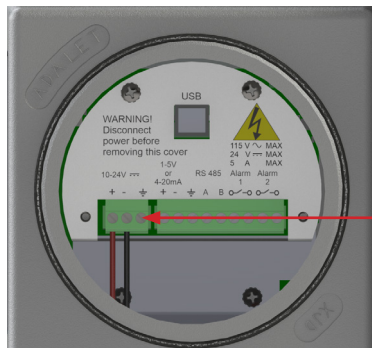

Shield Earth Ground
Terminal Connection

7. Connect the DC power wires to the appropriate terminals on the left.
- The + positive and - negative are clearly marked on the sheet metal cover
 - If you decide to use a 2-wire cable with shield for the power supply connection, AMI provides quality Shield Earth Ground Terminal Connection next to the + positive and - negative terminals

For AC Power:

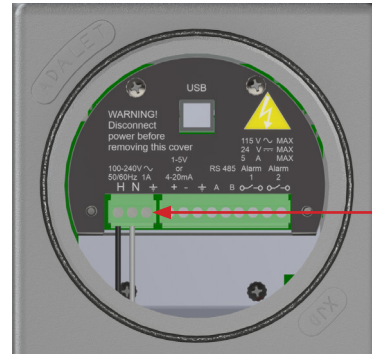

AC Power Ground
Terminal Connection (A)
(see recommendation
below)

7. Connect the AC power wires to the appropriate terminals on the left. The wire designations are clearly marked on the black metal cover.
- H is for the Hot Wire
 - N is for the Neutral Wire
 - Position (A), as shown above, is for the AC Power Ground

Protective Earth
Ground Lug



WARNING:

Analyzer must be connected to a Quality Protective Earth Ground for safety and the highest level of RFI protection. This is accomplished by connecting an 16-gauge wire from the Analyzer's Protective Earth Grounding Lug to an 8 foot ground rod or equivalent quality ground. (The Protective Earth Ground Lug is located just below the explosion-proof housing as seen in the image above)



WARNING:

When using a AC power, never rely on the AC Power Ground as a source for Analyzer safety or ground protection. Always connect the Protective Earth Ground Lug, shown above, to a high quality ground, such as an 8 foot ground rod or equivalent.

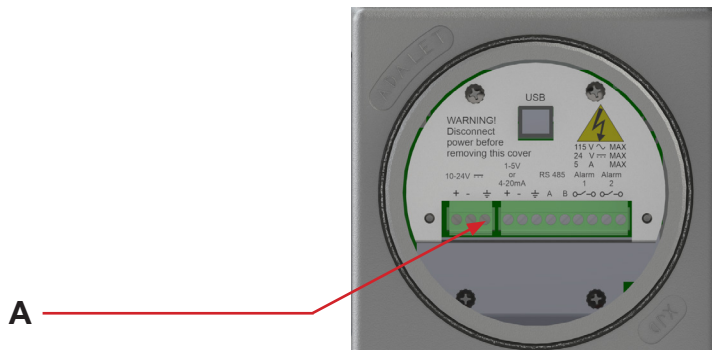

RECOMMENDED: WHEN USING DC POWER, USE A SHIELDED-TWISTED PAIR CABLE AND CONNECT THE CABLE SHIELD TO THE SHIELD EARTH GROUND TERMINAL SHOWN IN POSITION 'A' OF THE ILLUSTRATION BELOW. DO NOT CONNECT THE OTHER END OF THE SHIELD WIRE AS IT WILL CAUSE UNDESIRABLE GROUND LOOPS!

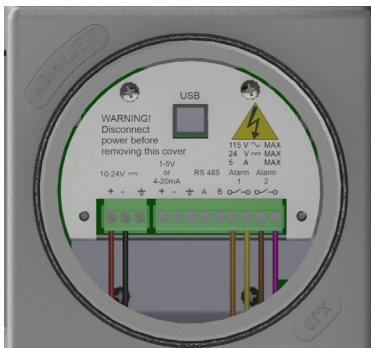

(DC Power Version is shown for alarm wiring. The AC version will be identical for alarms, analog output and RS-485 connections.)

- Connect the wires for the two fully adjustable alarm contact relays to their proper terminals.

Note: Both alarm relays are rated for 5A @115VAC or 24VDC.

IMPORTANT: IF YOU DESIRE TO USE THE ALARM CONTACT RELAYS, THE ALARM WIRES MUST BE PULLED THROUGH THE SAME CONDUIT AS THE SUPPLY POWER.

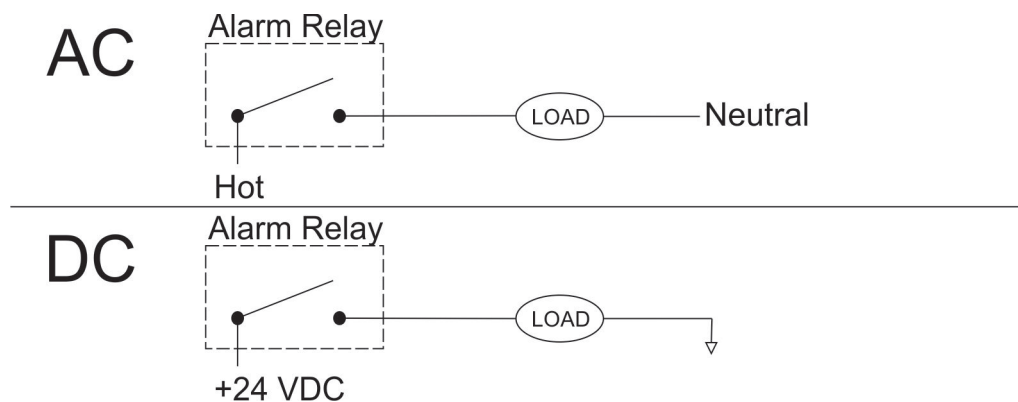

IMPORTANT: The relay contacts act like a simple switch breaking only a single leg of the circuit. In keeping with good electrical practices while wiring the alarm contacts, We suggest **SWITCH/BREAK THE HOT LEG only, NOT THE GROUND LEG OF YOUR CIRCUIT.**

2nd CONDUIT (ANALOG OUTPUTS & RS485 COMMUNICATION):

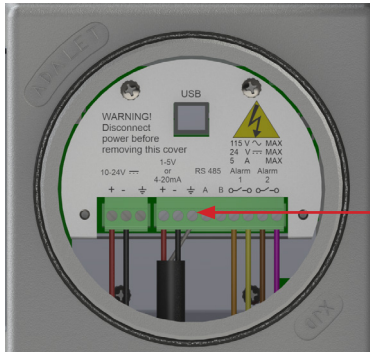

(DC Power Version is shown. Instructions are the same for the AC Power Version)

Analogue Output should be connected using a twisted 2-conductor wire with shield

NOTE: Always use a twisted 2-conductor cable with shield. **Never connect both ends of the shield to both devices (Analyzer and other device) as it will cause ground loops.** Connect the analog output shield to the shield earth ground shown above.

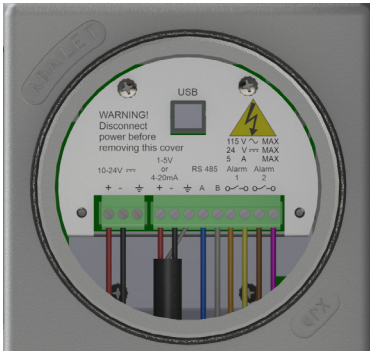

(DC Power Version is shown. Instructions are the same for the AC Power Version)

9. Last, connect the wires for RS485 communication to their proper terminals.
10. Verify all electrical connections and then turn on the source of power. The Analyzer will power-up and the LCD will blink for a few seconds during power-up. You may see some LEDs blinking within the explosion-proof housing and NEMA 4X box as this is normal during operation.
11. Once you have tested all electrical functions, pour approved potting compound into the electrical seal-offs.

INITIATION OF THE PRESSURE SENSOR

IMPORTANT: YOU MUST CALIBRATE THE PRESSURE SENSOR READING TO 0.0 PRIOR TO ANY GAS CONNECTIONS. THIS WILL CORRECT FOR ELEVATION VARIATIONS.

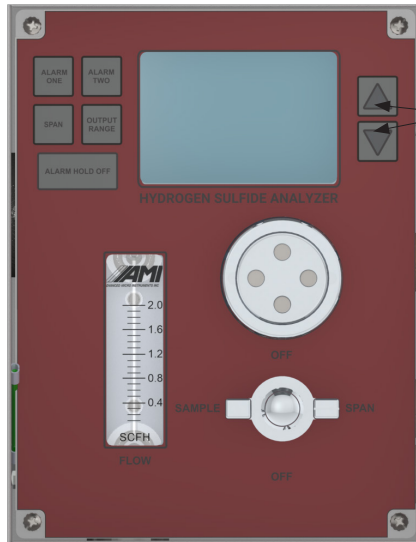

Up and Down
Arrow Buttons



Pressure Reading

12. Press and hold the DOWN ARROW BUTTON until the 'PSI' indication on the LCD begins to blink (this will take a few seconds).
13. Then press the UP and DOWN ARROW BUTTONS until the pressure reading goes to a value of **'0.0 PSI'**.
14. The LCD will revert back to operation mode in ~ 3 seconds when no buttons are pressed.

Part III: Gas Connections

Key Points:

- Sample Gas Inlet Pressure: You must have a minimum pressure of 0.5 psig for gas to flow through the Analyzer.
- **WARNING**
The maximum allowable inlet pressure for safe operation is 150 psig. Sites, where gas pressure exceeds 150 psig, require a pressure reducing regulator installed between the pipeline tap and Analyzer.
- **CAUTION**
When the sample gas is hot and wet, it could cause water to condense in the Sample Line or Analyzer
- For best operation, we recommend installing an AMI **Demister** and **Analyzer Guardian**, which can be purchased separately



Demister

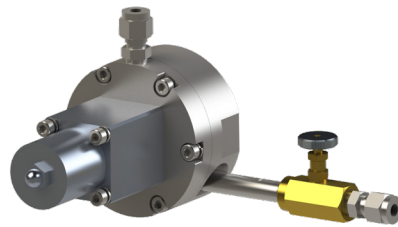

Analyzer Guardian

- The vertically-mounted Demister is designed to quickly and effectively reduce sample pipeline gas temperatures to ambient. The Demister rapidly cools warm, saturated gas, causing the liquids to condense out and drain back into the pipeline without requiring maintenance of other solutions, such as drip pots and coalescing filters
 - The Analyzer Guardian mounts directly on top of the Demister. It uses a combination of a hydrophobic/oleophobic membrane and perforated flexible stainless-steel disc that work in tandem, creating a barrier against saturated/wet gas, liquid slugs and particulates commonly found in pipeline gas.
 - The Analyzer Guardian is designed to automatically shut-off gas flow to the gas analyzer when a liquid slug occurs. Once the liquid slug passes, gas flow will resume.
- All gas connections will require using the supplied ferrule set, 1/4" stainless steel compression fittings and tubing

STEPS

THE MODEL 3010BX has 3 gas connections on its right side.

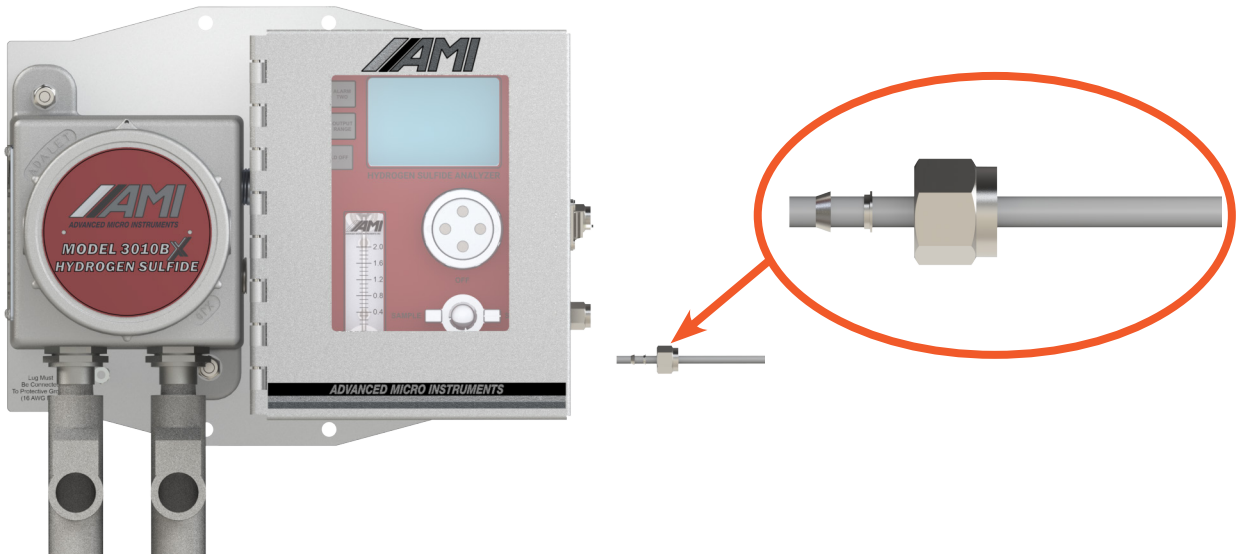
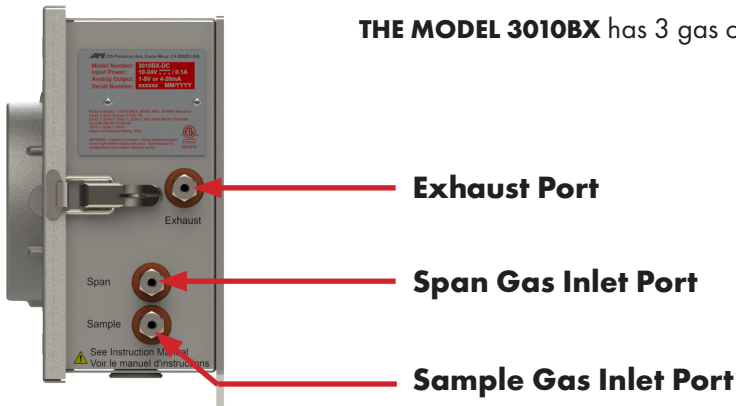

1. Take a deburred length of 1/4" stainless steel tubing and slip it through the supplied compression nut and ferrule set. Confirm that the ferrule properly orientated at one end, and connect it to the SAMPLE GAS INLET PORT.

Make sure the 1/4" stainless steel tubing slips all the way into the compression fitting until it bottoms out. Tighten the compression nut with 1 & 1/4 turns.

2. Connect the other end to the pipeline gas tap, pressure reducing regulator or an AMI Analyzer Guardian with Demister.

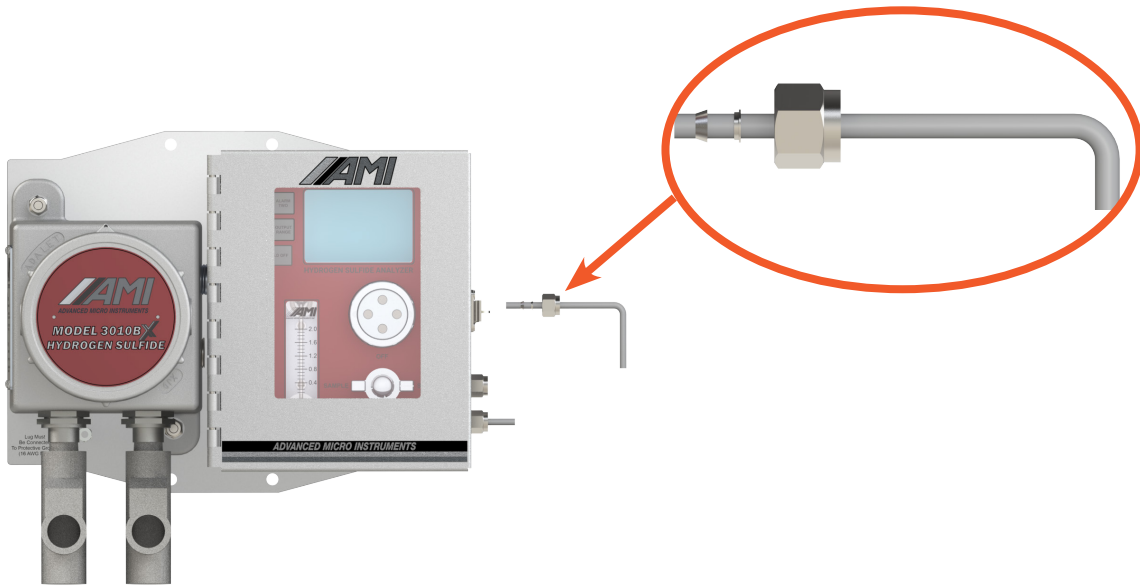

3. Take another deburred length of 1/4" stainless steel tubing and slip it through the supplied compression nut and ferrule set. Confirm that the ferrule set is properly oriented and then connect to the EXHAUST PORT.

Make sure the 1/4 stainless steel tubing slips all the way into the compression fitting until it bottoms out. Tighten the compression nut with 1 & 1/4 turns.

4. Run the other open end of the 1/4" stainless steel tubing to a safe vented area outside of the meter building.



CAUTION

The EXHAUST LINE must run slightly downhill the entire way to a safe area to allow any condensate to drain outside and not back into the Analyzer. If you must run the EXHAUST LINE vertically through the ceiling, install a 'knock-out' pot to capture the liquid condensate just prior to going vertical. This will prevent condensate from running back into the Analyzer.

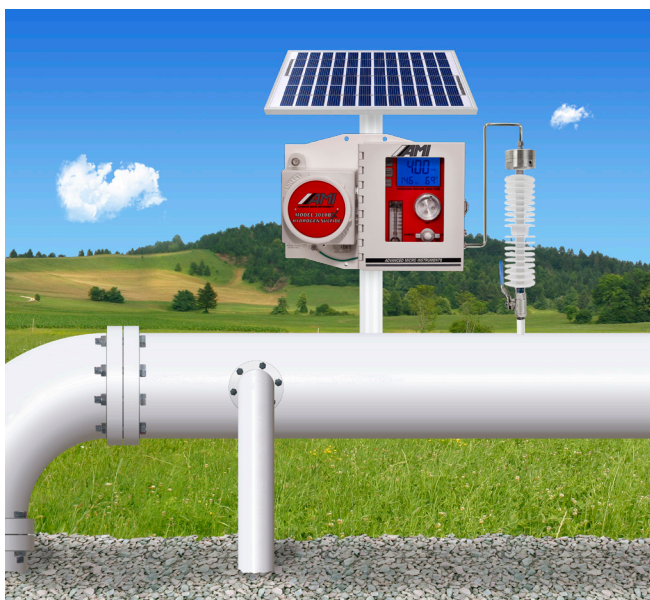

View of the installation of the Analyzer with the proper orientation of the LRP and Demister

INITIATION OF SAMPLE FLOW TO THE ANALYZER

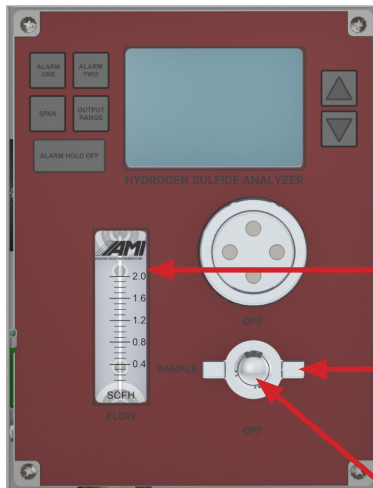

CAUTION:

DO NOT OVERTIGHTEN THE METERING VALVES or you will damage them. They are not ON/OFF VALVES!

Flow Meter

**3-way Selector Valve
(Sample/Span/Off)**

Metering Valve

Flow Meter

The flow meter indicates the flow rate of either the sample or span gas through the Analyzer.

3-way Selector Valve

This valve selects what gas flows past the sensor. You can rotate this valve clockwise or counter-clockwise. In the SAMPLE position, sample gas will flow past the sensor. In the SPAN position, span gas from the connected cylinder will enter through the SPAN GAS INLET PORT and flow past the sensor (note: this port is provided for periodic calibrations). In the OFF position, both SAMPLE GAS INLET PORT and SPAN GAS INLET PORT are blocked, which prevents any gas flow.

Metering Valve

This valve is located at the center of the 3-WAY SELECTOR VALVE and used for adjusting both sample and span gas flow rates. Turning the knob clockwise decreases the flow, while rotating it counter-clockwise increases the flowrate.

STEPS

1. Leak check the newly installed sample gas line. Rotate the 3-WAY SELECTOR VALVE to the OFF position. Then pressurize the sample line to ~ 20 to 100 psig. Use a squeeze bottle of SNOOP® or equivalent product and leak check every fitting from the SAMPLE GAS INLET PORT back to the sample tap (note: bubble formations indicate a leak). DO NOT USE the spray bottle as this technique produces bubbles and does not achieve the best results.
2. Rotate the 3-WAY SELECTOR VALVE to the SAMPLE position. Then, slowly adjust the METERING VALVE until the FLOW METER reads ~ 1.0 SCFH.
3. Allow the sample gas to purge the tubing and Analyzer.

END OF INSTALLATION

SENSOR INSTALLATION

Note: The Analyzer is shipped with an H₂S sensor already installed.

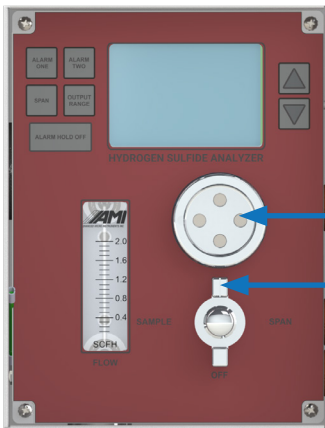

Cell Cap (The H₂S sensor is located behind the Cell Cap)
3-way Selector Valve
in the OFF Position

SENSOR REPLACEMENT



1. Turn the 3-WAY SELECTOR Valve to the OFF position.
2. Remove the CELL CAP by turning it counterclockwise.
3. Remove the expired sensor.
4. Open the bag containing the new hydrogen sulfide sensor.
5. Orientate the new hydrogen sulfide sensor and place into the sensor pocket as shown in the image above.

6. Place the CELL CAP back on and secure it by turning clockwise. If having trouble sealing, see note below for sealing techniques.
7. Follow the calibration steps in the next section.
8. Turn the 3-WAY SELECTOR VALVE back to the SAMPLE position.
9. Place the CELL CAP back on and secure it by turning clockwise.

Note: To seal the sensor, hand tight is normally all that is required. If more torque is needed, first purge, then remove the sensor, clean the mating surfaces in the pocket and the o-ring on the sensor with Isopropyl alcohol and a clean lint-free cloth. Add new lubrication, DuPont Molykote 55 O-Ring Grease or equivalent, to the sealing surface of the o-ring and reinstall. Once installed, wait for the reading from the sensor to fully stabilize in span gas – which can take 10-45 minutes, depending on flow rates and then proceed with calibration steps.

IMPORTANT:

The Analyzer configuration is SPECIFIC to the H₂S Sensor it uses.
The MODEL 3010BX Low Range Configuration can only use the Low Range H₂S Sensor (0-200ppm).
The MODEL 3010BX High Range Configuration can only use the High Range H₂S Sensor (0-2000ppm).
Changing the measurement configuration of the MODEL 3010BX requires getting the correct H₂S Sensor for proper operation.

CALIBRATION

Note: Every **MODEL 3010BX** unit undergoes rigorous internal quality tests prior to shipping. This includes a complete electronics and in-depth gas test.

Calibrate your Analyzer monthly using a calibration gas standard with your desired range of H₂S in a background of nitrogen. We recommend 50ppm H₂S in a background of nitrogen for our low range (0–200 ppm) model.

If you are calibrating the high range **MODEL 3010BX** Analyzer (0–2000 ppm) with a Span Gas, we recommend a Span Gas of 50 ppm, but < 200 ppm for safety reasons.

CALIBRATION WITH A SPAN GAS

We encourage you to view our calibration video at www.amio2.com before starting.

REQUIRED COMPONENTS:

- Certified span gas with 50 ppm H₂S in background of nitrogen, but no more than 200 ppm
- Stainless-steel or brass body pressure-reducing regulator that is outfitted with inlet/outlet pressure gauges, with the outlet port being a compression fitting for 1/4" tube (note: the regulator must have a diaphragm, made from one of the following materials – best option: stainless steel, secondary option: aluminum, or tertiary option: brass)
- AMI-supplied flexible (non-diffusive) tubing or a length of stainless steel tubing
- Tank wrench

CALIBRATION STEPS

1. Connect the AMI-supplied non-diffusive flexible tubing or stainless steel tubing from the regulator outlet fitting to the Span Inlet Gas Port.
2. Open the valve of the Span Gas Tank and adjust the regulator pressure to approximately 20 psig.
3. Press the ALARM HOLD OFF button if you are utilizing the alarm feature to avoid an alarm condition.
4. Rotate the 3-WAY SELECTOR VALVE, located on the front panel of the Analyzer, to the SPAN position and adjust the flow rate to approximately 1 SCFH.
5. Allow the measurement reading to stabilize for 20 minutes.
6. Span the Analyzer to the value of the H₂S, specified on the Span Gas Tank, by doing the following:

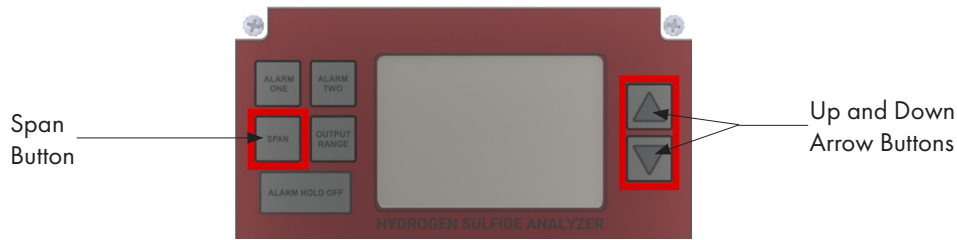

Press the SPAN Button and release. The word SPAN will appear on the LCD for 1 second and then display the H₂S reading, while the PPM FLAG blinks. Quickly press the appropriate UP/DOWN ARROW to adjust the LCD reading to the value stated on your calibration gas cylinder.

7. Once completed, wait for a few seconds. The PPM FLAG will stop blinking, and the Analyzer will accept the new calibration.
8. Turn the 3-WAY SELECTION VALVE back to the SAMPLE position (the H₂S reading will quickly drop to the value of the pipeline gas).

DISPLAYING THE CURRENT SPAN FACTOR

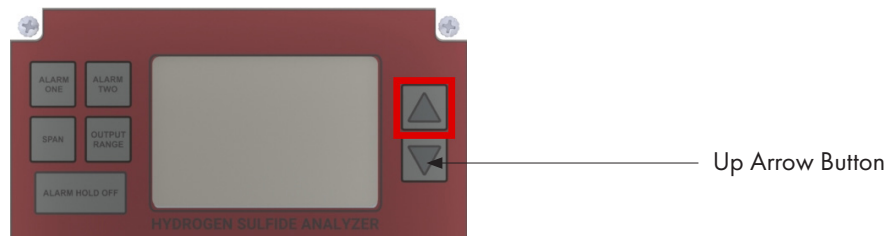

Press the UP ARROW BUTTON.

IMPORTANT:

The SPAN FACTOR is an indication of sensor life. The span factor is accurate only after an accurate calibration has been completed.

The SPAN FACTOR of a new H₂S sensor is in the range of 400 to 600.

Over time, as the H₂S sensor ages, each calibration should require an adjustment with the UP ARROW BUTTON to correct for any degradation of the electrochemical sensor output (note: the degradation is approximately 1% of the reading per month).

When the SPAN FACTOR reaches around 980, it will become necessary to replace the sensor during the next calibration.

If you are calibrating the high range MODEL 3010BX Analyzer (0 – 2000 ppm), we recommend a Span Gas > 200 ppm for safety reasons.

ANALYZER OPERATION

Front Panel Interface

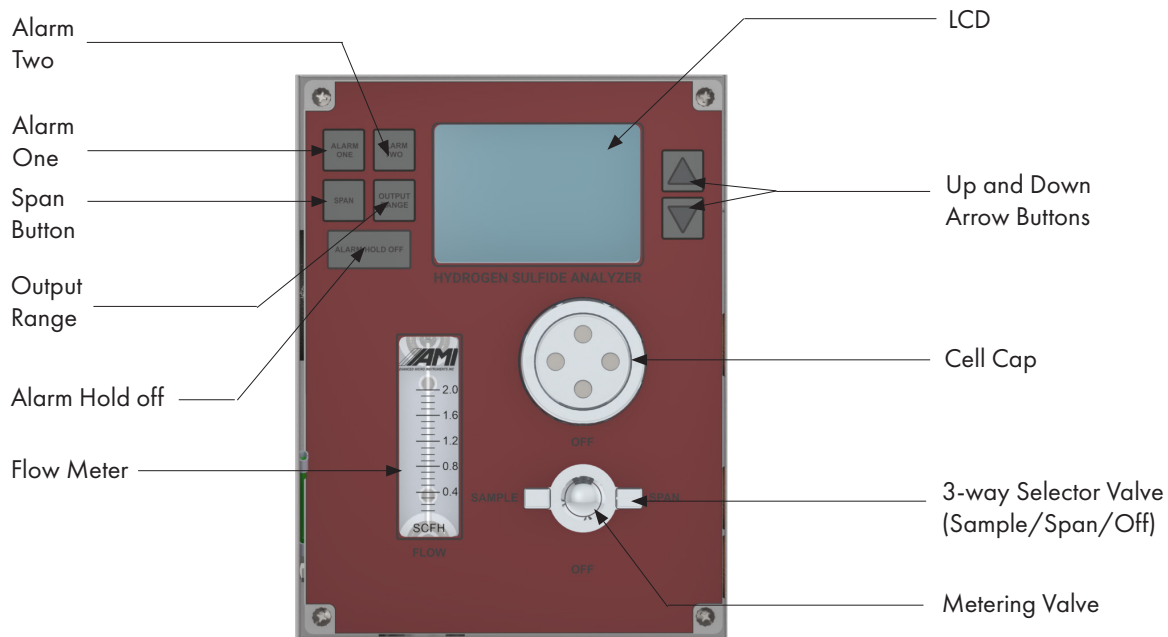

Readings on the LCD

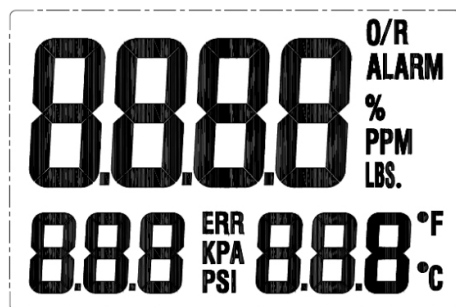

- 1) H_2S readings are displayed in ppm or %, based on the current reading level.
- 2) Operating Temperature can be displayed in either Fahrenheit ($^{\circ}F$) or Celsius ($^{\circ}C$).
Note: Fahrenheit is the factory default unit for temperature. Users can switch to Celsius by changing the settings in the **COMMAND CENTER User Interface Software**. Refer to the **COMMAND CENTER** Operator Manual for the proper instructions.
- 3) Inlet Gas Pressure is can be displayed in either psi or kPa.
Note: 'psi' is the factory default unit for gas presssure. Users can switch to kPa by changing the settings in the **COMMAND CENTER User Interface Software**. Refer to the **COMMAND CENTER** Operator Manual for the proper instructions.
- 4) The LCD will display 'ALARM' if either ALARM has been triggered.
- 5) The LCD will display 'ERR' if any 'fail-safe' error has been detected by the Analyzer.

Changing the Analog Output Range of the measurement readings on the LCD

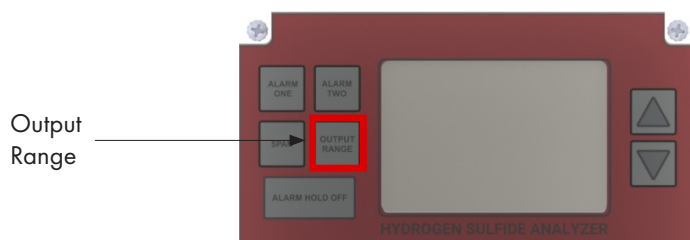

Important:
Your selected Analog Output Range will correlate to the Alarm Range and the Analog Output Range. For example, if the Output Range is set to 0 – 10ppm, the Alarm Range is 0 – 10ppm. The Analog Output will scale within the selected Analog Output Range and Alarms.

Analog Output Ranges

- Standard:** 0 – 10 ppm, 0 – 50 ppm, 0 – 100 ppm, 0 – 200 ppm
- Optional:** 0 – 100 ppm, 0 – 500 ppm, 0 – 1000 ppm, 0 – 2000 ppm

Press the OUTPUT RANGE button. The LCD screen will display the current Output Range. Within 3 seconds, use the UP AND DOWN ARROW BUTTONS to scroll the choices and select your desired output range. Once completed, do not push any buttons and wait for a couple of seconds. Your new output range will be saved and the Analyzer will revert to measurement mode.

Setting the Alarms on the MODEL 3010BX

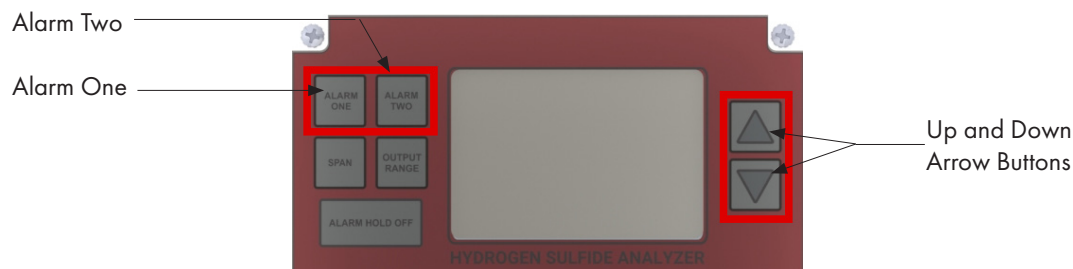

THE MODEL 3010BX comes standard with two fully, adjustable independent alarms (ALARM ONE and ALARM TWO).

To set ALARM ONE, press the ALARM ONE Button and quickly release. The LCD alarm flag will blink, and within 3 seconds, press either the UP or DOWN ARROW BUTTON to adjust your alarm setpoint. Once pressed, just hold the button until you reach your desired alarm setpoint. The longer you hold, the faster the alarm setpoint adjusts. If no buttons are pressed within 3 seconds, the Analyzer will revert to measurement mode.

If you make a mistake at any time, simply let go of the button for 3-4 seconds, and the LCD will return to measurement mode. Then try again.

To set ALARM TWO, repeat the same steps as used in ALARM ONE.

Note: Your alarm setpoint will be fully adjustable within your selected output range.

Setting the Alarm Hold Off

NOTE:

The ALARM HOLD OFF allows you to bypass the Alarm Relay Function for a predetermined amount of time. The feature is helpful to use during monthly or quarterly gas calibrations so as not to set off alarm components driven by the Relay contacts.

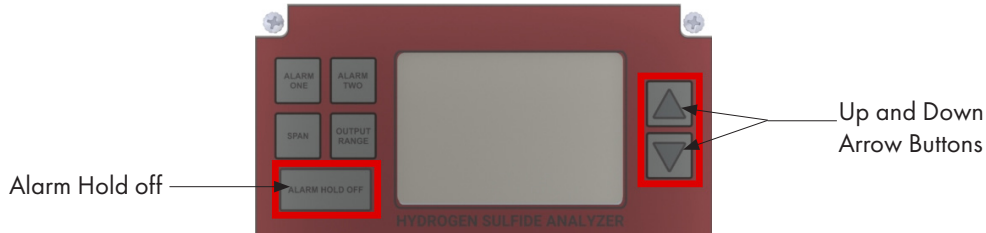

Press the ALARM HOLD OFF button, and the Alarm Hold Number will appear in minutes. Within 3-4 seconds, push either the UP or DOWN ARROW BUTTON to adjust the duration of your ALARM HOLD OFF. The ALARM HOLD OFF can be engaged from 0 to 120 minutes. The HOLD OFF feature holds-off both ALARMS and ANALOG OUTPUT.

After the time for setting the ALARM HOLD OFF expires, both Alarms and the Analog Output will revert to measurement mode.

ADDITIONAL NOTES:

If you need more time for the setup, simply push the ALARM HOLD OFF Button again, and it will automatically reset to the original Hold Off Time.

If you are completing a Calibration before the 'Hold Off' Set Time elapses and want the Alarms and Analog Output to become functional immediately, you can simply run the Hold Off Time to zero by pushing the Hold Off Button until the LCD blinks and then pushing the DOWN ARROW BUTTON until the LCD shows zero.

Changing Display to Metric Units

To change the units, the **COMMAND CENTER Software** needs to be installed on a laptop computer (see the **COMMAND CENTER Software Set-up Section** in this manual), and that computer needs to be connected to the Analyzer prior to proceeding.

This section will require a password. Contact AMI before proceeding with the instructions below.

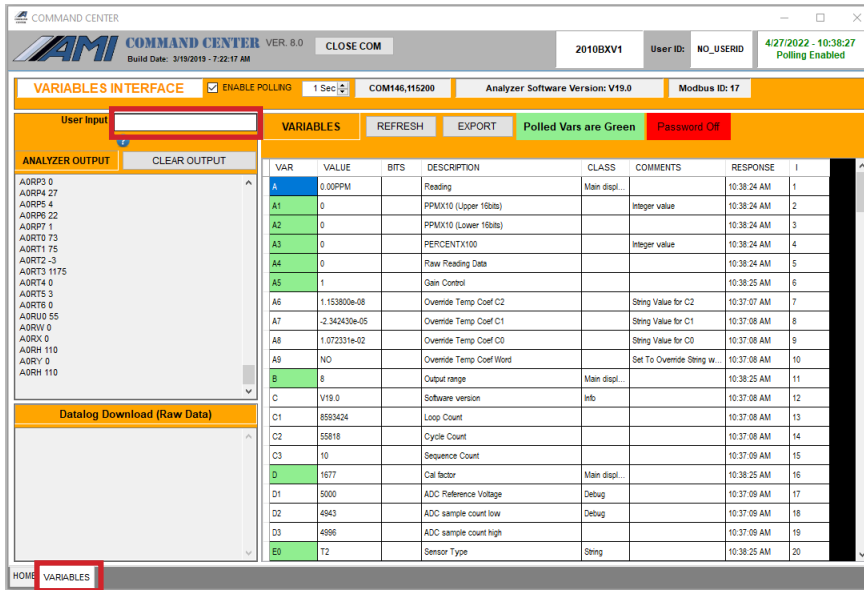

Note: MODEL 2010BX Screenshots shown

- Click on the 'VARIABLES' Tab at the bottom left-hand window.
- Click the 'USER INPUT' Cell at the upper left-hand area of the window.

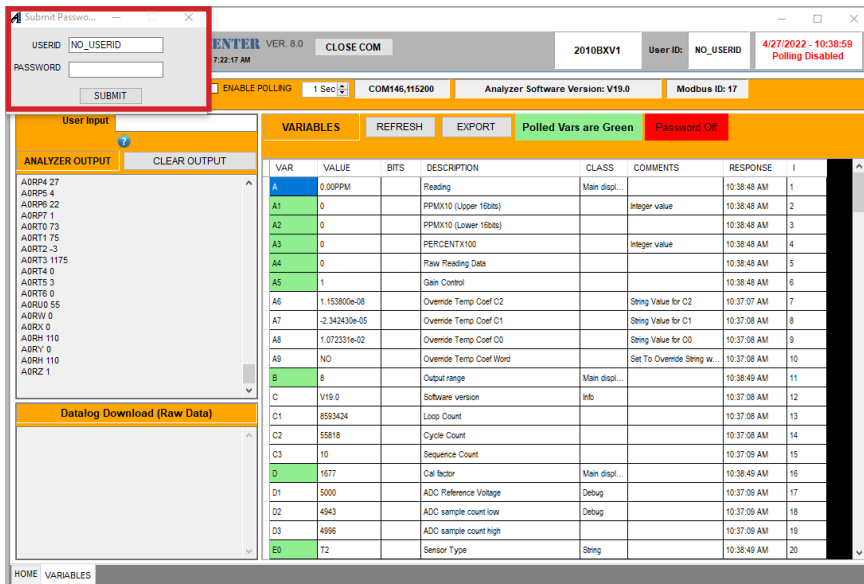

- Once the small SUBMIT PASSWORD window opens, enter the password that you received and press SUBMIT.

COMMAND CENTER VER. 8.0
Build Date: 3/19/2019 - 7:22:17 AM

CLOSE.COM 2010BXV1 User ID: NO_USERID 4/27/2022 - 10:38:27 Polling Enabled

VARIABLES INTERFACE ENABLE POLLING 1 Sec COM146,115200 Analyzer Software Version: V19.0 Modbus ID: 17

User Input: [Empty]

ANALYZER OUTPUT: CLEAR OUTPUT

VAR	VALUE	BITS	DESCRIPTION	CLASS	COMMENTS	RESPONSE	I
A	0.00PPM		Reading	Main displ...		10:38:24 AM	1
A1	0		PPMX10 (Upper 16bits)		Integer value	10:38:24 AM	2
A2	0		PPMX10 (Lower 16bits)			10:38:24 AM	3
A3	0		PERCENTX100		Integer value	10:38:24 AM	4
A4	0		Raw Reading Data			10:38:24 AM	5
A5	1		Gain Control			10:38:25 AM	6
A6	1.153800e-08		Override Temp Coef C2		String Value for C2	10:37:07 AM	7
A7	-2.342430e-05		Override Temp Coef C1		String Value for C1	10:37:08 AM	8
A8	1.072331e-02		Override Temp Coef C0		String Value for C0	10:37:08 AM	9
A9	NO		Override Temp Coef Word		Set To Override String w...	10:37:08 AM	10
B	8		Output range	Main displ...		10:38:25 AM	11
C	V19.0		Software version	Inf		10:37:08 AM	12
C1	8593424		Loop Count			10:37:08 AM	13
C2	55818		Cycle Count			10:37:08 AM	14
C3	10		Sequence Count			10:37:09 AM	15
D	1677		Cal factor	Main displ...		10:38:25 AM	16
D1	5000		ADC Reference Voltage	Debug		10:37:09 AM	17
D2	4943		ADC sample count low	Debug		10:37:09 AM	18
D3	4956		ADC sample count high			10:37:09 AM	19
E0	T2		Sensor Type	String		10:38:25 AM	20

HOME VARIABLES

- Uncheck ENABLE POLLING.
- Click CLEAR OUTPUT.

COMMAND CENTER VER. 8.0
Build Date: 3/19/2019 - 7:22:17 AM

CLOSE.COM 2010BXV1 User ID: NO_USERID 4/27/2022 - 10:43:18 Polling Disabled

VARIABLES INTERFACE ENABLE POLLING 1 Sec COM146,115200 Analyzer Software Version: V19.0 Modbus ID: 17

User Input: CENTIGRADE

ANALYZER OUTPUT: CLEAR OUTPUT

VAR	VALUE	BITS	DESCRIPTION	CLASS	COMMENTS	RESPONSE	I
A	0.00PPM		Reading	Main displ...		10:41:20 AM	1
A1	0		PPMX10 (Upper 16bits)		Integer value	10:41:20 AM	2
A2	0		PPMX10 (Lower 16bits)			10:41:20 AM	3
A3	0		PERCENTX100		Integer value	10:41:21 AM	4
A4	0		Raw Reading Data			10:41:21 AM	5
A5	1		Gain Control			10:41:21 AM	6
A6	1.153800e-08		Override Temp Coef C2		String Value for C2	10:37:07 AM	7
A7	-2.342430e-05		Override Temp Coef C1		String Value for C1	10:37:08 AM	8
A8	1.072331e-02		Override Temp Coef C0		String Value for C0	10:37:08 AM	9
A9	NO		Override Temp Coef Word		Set To Override String w...	10:37:08 AM	10
B	8		Output range	Main displ...		10:41:21 AM	11
C	V19.0		Software version	Inf		10:37:08 AM	12
C1	8593424		Loop Count			10:37:08 AM	13
C2	55818		Cycle Count			10:37:08 AM	14
C3	10		Sequence Count			10:37:09 AM	15
D	1677		Cal factor	Main displ...		10:41:21 AM	16
D1	5000		ADC Reference Voltage	Debug		10:37:09 AM	17
D2	4943		ADC sample count low	Debug		10:37:09 AM	18
D3	4956		ADC sample count high			10:37:09 AM	19
E0	T2		Sensor Type	String		10:41:21 AM	20

HOME VARIABLES

- Type 'CENTIGRADE' into the User Input area (shown above in the red box) and press RETURN. This will change BOTH Temperature to Celsius and Pressure to kPA.

Note: To return to Imperial Units, enter 'FAHRENHEIT' and press RETURN.

THIS PAGE LEFT INTENTIONALLY BLANK

To access the more sophisticated features available on **MODEL 3010BX** requires installing the current version of the **COMMAND CENTER Software**.

COMMAND CENTER SOFTWARE SET-UP

Step 1: Remove the explosion-proof cover to access the USB Port (Type B) of the Analyzer

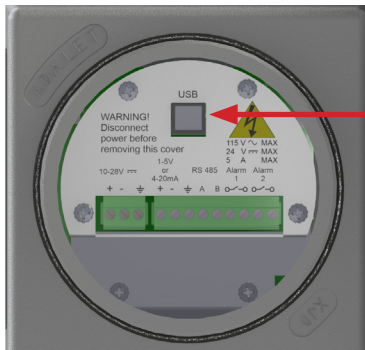

USB Port (Type B)

(DC Power Version is shown. Instructions are the same for the AC Power Version)

Step 2: Establish a Communication Link between your Laptop and the Analyzer

- a) Power up your Laptop and open the current version of the **COMMAND CENTER User Interface Software**.

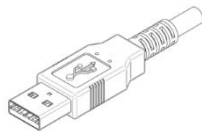

USB Type A Connector



USB Type B Connector

- b) Using a USB cable with a Type A Connector on one end and a Type B Connector on the other, insert the Type A Connector into the USB port of your laptop and the Type B Connector into the USB port of the Analyzer on the Explosion-proof side.

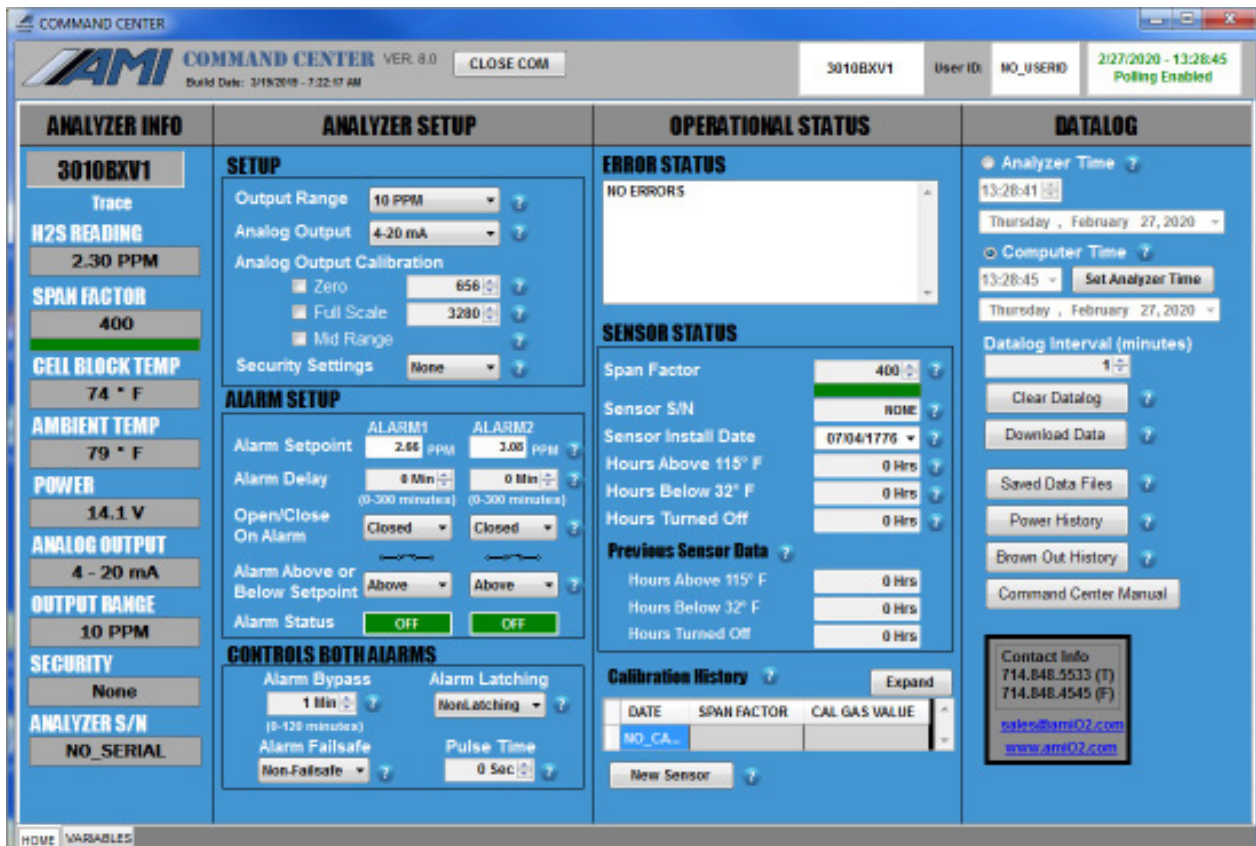

Above: **COMMAND CENTER Software** window shown with settings for **MODEL 3010BX**

c) Once the link is established, the software will automatically recognize the Analyzer and populate the Analyzer Info Column with information specific to your Analyzer.

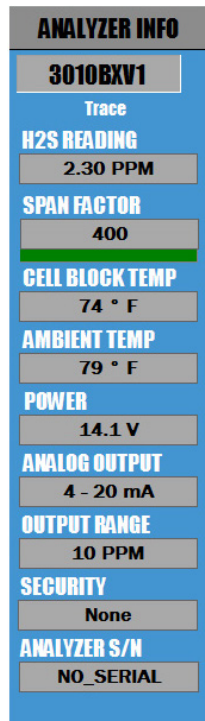

View of the Left Status Column of the User Interface

d) The Analyzer Info Column will display the following information about your Analyzer:

- Analyzer Model Number
- Trace H₂S Reading in ppm
- Span Factor
- Cell Block Temperature
- Ambient Temperature
- Input Power, either AC or DC
- Analog Output Setting (4–20mA or 1–5 VDC)
- Output Range Selection
- Security Selection
- Analyzer Serial Number

Step 3: Selection of Options in Analyzer Setup Area & Syncing with EFM

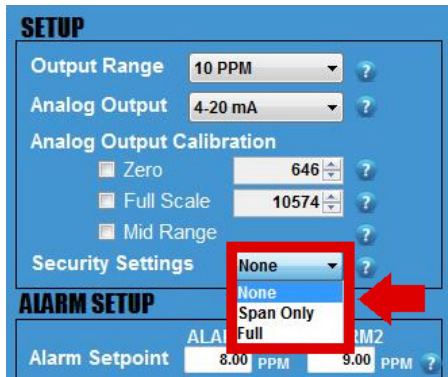

- a) Set your desired SECURITY SETTINGS.
You have 3 options available to select from:
- NONE allows anyone to make changes to the Analyzer's settings using the front panel
 - SPAN ONLY provides a technician the ability to use the ALARM HOLD-OFF feature and adjust the SPAN value during a gas calibration using the front panel. It will also allow you to push any button for a status but no adjustment. While in this security setting, once any alarm or output range button is pushed, the LCD will flash SSEC as an indication of the security setting and then display status
 - FULL **prevents** anyone from changing the Analyzer's settings using the front panel. However, you can still use the front panel to check the Analyzer's status values by pushing any of the buttons (i.e., pressing the ALARM ONE Button displays the setpoint for ALARM ONE, pressing the ALARM TWO Button displays the setpoint for ALARM TWO, and so on) While in the full security setting, once any front panel button is pushed, the LCD will flash FSEC as an indication of the security setting and then display status.
- Note: To make setting adjustment in the COMMAND CENTER, the 'NONE' Security Setting must be selected.

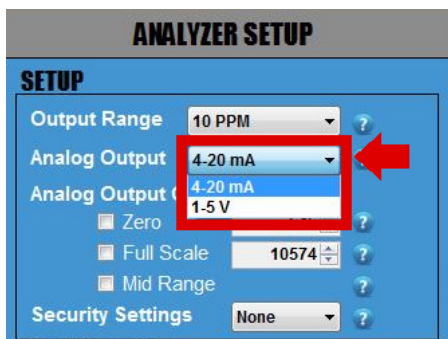

- b) View ANALOG OUTPUT Setting.
This is set and calibrated at the factory per your order requirements prior to shipping. If you wish to change the analog output from 4-20mA or 1-5 VDC or vice versa, refer to the instructions shown on page 31.

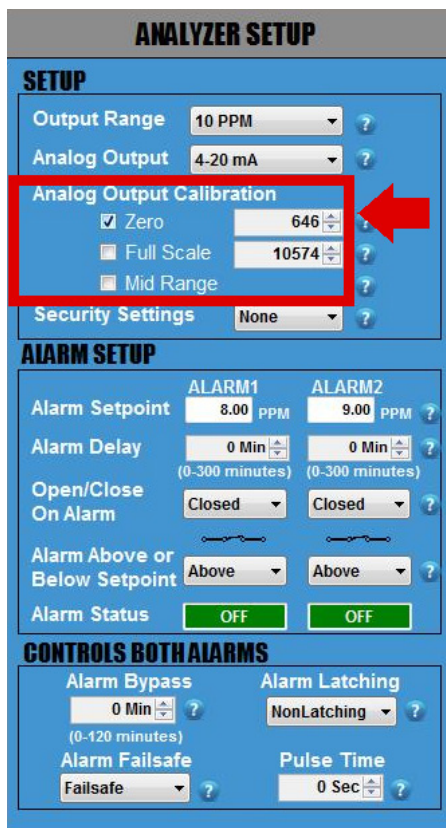

c) Sync your EFM (electronic flow meter) or similar device to your Analyzer.

The following steps are critical because they will ensure that both devices display the same measurement readings and, thereby, prevent unnecessary confusion in the future.

1. By now, you have already wired your EFM or similar device to the Analyzer using the Analyzer's analog output terminals.

2. Click on the small square box next to ZERO and the reading, and this will drive the analog output to exactly 4.00mA or 1.00VDC, depending on your selected output! Confirm that the reading on your EFM or similar device reads 0.00. If it does not, use the UP and DOWN ARROWS to the right of 'Zero' to adjust until the EFM or similar device now reads 0.00.

3. Once this is done, click on the square next to FULL SCALE, and this will drive the analog output to exactly 20.00mA or 5.00VDC, depending on your selected output.

Confirm that the reading on your EFM or similar device reads full scale. If it does not, use the UP and DOWN ARROWS to right of 'Full Scale' to adjust until the reading of the EFM or similar device reads FULL SCALE.

4. Repeat Step 2 (ZERO) and Step 3 (FULL SCALE) once more to confirm that both your EFM or similar device and the Analyzer are displaying the same readings.

5. Last, click on MID RANGE. This will check the linearity. There are no values to adjust as this is just a midpoint validation.

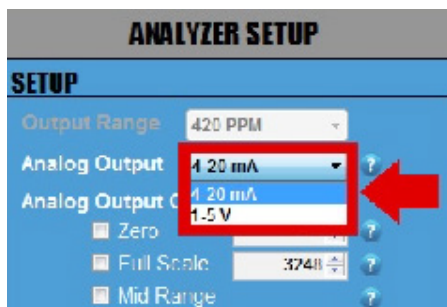

CHANGING ANALOG OUTPUTS (OPTIONAL)

d) Changing your ANALOG OUTPUT from 4–20mA to 1–5 VDC or vice versa. (Skip this step if you DO NOT want to change your ANALOG OUTPUT.)

Click on the drop down menu of ANALOG OUTPUT and select the output option that you wish to change to.

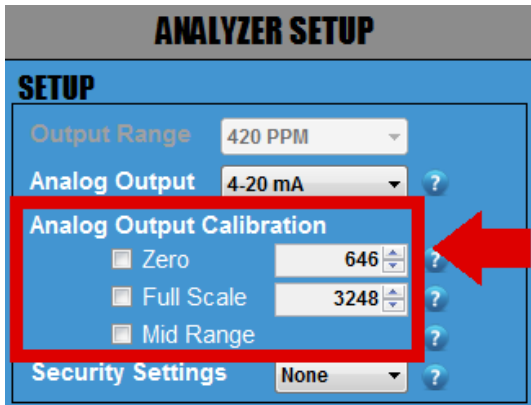

IMPORTANT

Whenever you change the ANALOG OUTPUT from 4–20mA to 1–5 VDC or vice versa, you will need to complete the following steps to verify your ANALOG OUTPUT. Remove any analog output wires from the Analyzer connection point!

1. Attach a multimeter to the Green Analog Out Terminal Connector of your Analyzer. Make sure your multimeter is set appropriately, either current for 4–20mA or voltage for 1–5 VDC .
2. Click on the square box next to ZERO to confirm that your multimeter is displaying either 4.00mA or 1.000VDC (the number of digits displayed on the screen will depend on the multimeter that you use). If the reading of the multimeter does not match the reading of the Analyzer, use the UP and DOWN ARROWS to the right of ZERO to adjust the values until the reading of the multimeter is either 4.00mA or 1.000VDC.
3. Once this is completed, click on the square box next to FULL SCALE to confirm that your multimeter is displaying either 20.00mA or 5.00VDC. If the reading of the multimeter does not match the reading of the Analyzer, use the UP and DOWN ARROWS to the right of FULL SCALE to adjust the values until the reading of the multimeter is now either 20.00mA or 5.00VDC .
- 4.. Repeat Step 2 (ZERO) and Step 3 (FULL SCALE) again until you can confirm that your multimeter is displaying 4.00mA or 1.000VDC for ZERO and 20.00mA or 5VDC for FULL SCALE.
5. Last, click on MID RANGE. This will check the linearity. There are no values to adjust as this is just a midpoint validation.
6. Once you have completed this section, disconnect the multimeter.

CAUTION

The values of the analog output SPAN and ZERO values must be set so that the analog output reflects the 1-5V or 4-20mA output during calibration.

ZERO value for 4ma or 1V output must be set between 500 to 700.

SPAN value for 20mA or 5V output must be set between 3000 to 3500.

If these values are not set correctly, the analog output will not behave correctly on the BX Series Analyzers.

Note: The previous values of SPAN and ZERO min and max values for the BR Series Analyzers are different than those for the BX Series Analyzers' min and max values.

Step 4: Alarm Logic & Setup

ALARM SETUP

	ALARM1	ALARM2
Alarm Setpoint	8.00 PPM	9.00 PPM
Alarm Delay	0 Min (0-300 minutes)	0 Min (0-300 minutes)
Open/Close On Alarm	Closed	Closed
Alarm Above or Below Setpoint	Above	Above
Alarm Status	OFF	OFF

CONTROLS BOTH ALARMS

Alarm Bypass	0 Min (0-120 minutes)
Alarm Latching	NonLatching
Alarm Failsafe	Failsafe
Pulse Time	0 Sec

The Analyzer features 2 independent H₂S Concentration Alarms –one for ALARM 1 and one for ALARM 2. The settings for these alarms, including setpoints, relay contacts, close/open logic and alarm delays, are adjusted through the **COMMAND CENTER**.

It is important that you plan out how you want your ALARM LOGIC to work for each ALARM before you start adjusting the settings discussed in this section.

ALARM SETUP

	ALARM1	ALARM2
Alarm Setpoint	8.00 PPM	9.00 PPM
Alarm Delay	0 Min (0-300 minutes)	0 Min (0-300 minutes)
Open/Close On Alarm	Closed	Closed
Alarm Above or Below Setpoint	Above	Above
Alarm Status	OFF	OFF

a) Set the ALARM SETPOINTS.

Enter your desired value for each setpoint and then press the ENTER key on your laptop. Keep in mind that your values cannot exceed the limit of the selected analog Output Range that you previously selected.

Both Alarms have a 1% hysteresis band that correlates with the customer selected output range. As the H₂S reading rises to the alarm setpoint, the relay will energize precisely the setpoint. As the H₂S reading drops, it will have to exceed a 1% hysteresis of the alarm setpoint before it de-energizes.

Example: Analog output range has been set for 0–100 ppm with an alarm set for 10 ppm. This relay will energize at exactly 10.0 ppm and de-energize at 9.9 ppm.

ALARM SETUP

	ALARM1	ALARM2
Alarm Setpoint	8.00 PPM	9.00 PPM
Alarm Delay	0 Min (0-300 minutes)	0 Min (0-300 minutes)
Open/Close On Alarm	Closed	Closed
Alarm Above or Below Setpoint	Above	Above
Alarm Status	OFF	OFF

b) Set the ALARM DELAYS.

There are 2 ALARM DELAYS. Each ALARM DELAY setting is located beneath the corresponding ALARM that it controls.

Enter your desired time duration for each ALARM DELAY and press the ENTER key on your laptop. You can also adjust using the UP and DOWN ARROWS. The range is from 0 to 300 minutes.

* This feature is especially helpful at custody transfer points when customers are allowed to exceed contractual limits for a predetermined amount of time.



c) Click on the drop-down menu and set the ALARM to trigger ABOVE SETPOINT or BELOW SETPOINT. This causes the alarm flag located on the LCD to illuminate in accordance with your desired setting and the alarm relay contact to open or close as configured in the next step.

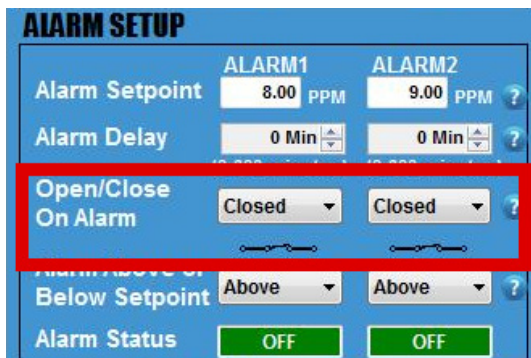

d) Click on the drop-down menu and set the alarm relay contact of each individual ALARM to OPEN or CLOSE when its respective ALARM is triggered.

Each alarm will be triggered above or below setpoint as you have selected in Step c).

The schematic symbol under the drop down menu represents the alarm logic that has been selected. If you select OPEN, the schematic will show an 'open' alarm relay contact. If you select CLOSED, the schematic will show a 'closed' alarm relay contact.

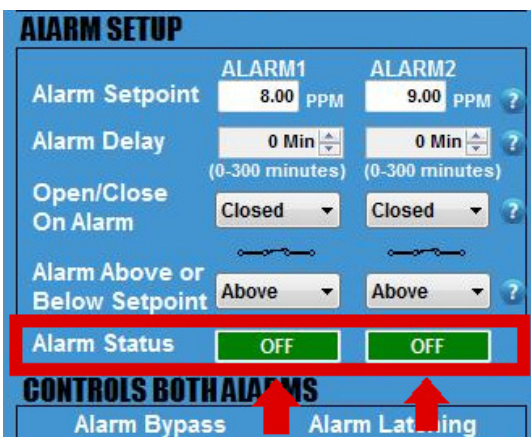

e) View the ALARM STATUS.

Both independent ALARMS have their own ALARM STATUS.

If an ALARM is not triggered, the ALARM STATUS will display 'OFF' in green.

If an ALARM is triggered, its ALARM STATUS will display 'ON' in red.

* For an ALARM to be triggered, it will take into account the complete logic of how the ALARM was set up. This includes SETPOINT, DELAY, OPEN/CLOSE CONTACT ON ALARM, and ALARM ABOVE OR BELOW SETPOINT.

Step 5: Setup of the Controls for Both Alarms

IMPORTANT:

For this section, the adjustments discussed below will affect both ALARMS and **CANNOT** be set independently for each ALARM.



- a) Set the ALARM BYPASS. Use the UP and DOWN ARROWS to set the duration of your ALARM BYPASS (HOLDOFF).

*This is a helpful feature during a routine sensor calibration so that you do not set off alarm devices.

*This feature disables both ALARMS and ANALOG OUTPUTS for those of you using the analog output for control..



- b) Click on the drop-down menu and set the ALARM relay contacts to LATCHING or NONLATCHING.

-If set to NONLATCHING, the relay contacts will energize when the measurement readings exceeds the ALARM SETPOINTS and then de-energize when the measurement readings drop below the ALARM SETPOINTS.

- If this is set to LATCHING, the relay contacts will energize when the measurement readings exceeds the ALARM SETPOINTS but also remain engaged when the reading drops below the ALARM SETPOINTS. A person will have to press the ALARM HOLDOFF Button for 1 second on the front panel of the Analyzer to disengage the relay contacts.



LOW POWER FAILSAFE/NON-FAILSAFE

- c) Click on the drop-down menu and set the ALARMS to FAILSAFE or NON FAILSAFE.

- If set to FAILSAFE, the ALARMS will trigger if the power supplied to the Analyzer drops below 8.5V. However, the ALARMS will not clear until the power moves back up and exceeds 12V.

- If set to NONFAILSAFE, the ALARMS will not trigger if the power supplied to the Analyzer drops below 8.5V.



CAUTION: DO NOT adjust this setting unless you are using a pulse-latch slam valve! Otherwise, you will override the relay logic for your Alarms.

- d) CHECK WITH THE VALVE MANUFACTURER for the correct pulse time and then set this PULSE TIME (in seconds) using the UP and DOWN Arrows.

This sets the duration of time that the Analyzer sends power to the relay contacts to open or close the valve when an ALARM is triggered. The ALARM 1 Contact will open the slam valve, while the ALARM 2 Contact will close the valve.

This features is helpful because it eliminates the need to continually draw power while the valve is closed.

Step 6: Datalog Interval & Setup

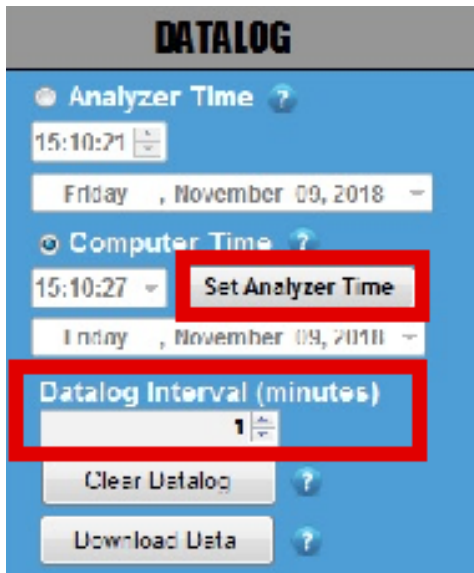

- a) SET ANALYZER TIME
Click the Analyzer Time and manually set the time. Or click Computer Time and then the SET ANALYZER TIME Button. The time should automatically adjust and closely match the time shown on your laptop.

- b) DATA COLLECTION INTERVAL (minutes)
Then set your desired collection interval for the DATALOGGER by adjusting the time (in minutes). The DATALOGGER allows you to store a time-stamped recording of the measurement reading, inlet gas pressure, temperature of the CELL BLOCK, power supply voltage and minimum voltage supplied to the Analyzer.

Note: The default setting has the DATALOGGER collects data for 15 days in 1-minute intervals. If you increase the duration of the interval, the data collection period also increases proportionally. Therefore, if you increase the interval to 2 minutes, the data collection period adjusts to 30 days. Every 3 minutes will increase the collection period to 45 days and so forth.

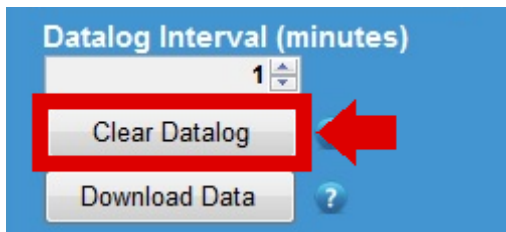

- c) CLEAR DATA LOG
Press the CLEAR DATALOG Button to clear any recorded data performed at the factory.



You can also view Saved Data Files, Power History, Brown-out History, and the Manual by pressing their respective buttons in this column.

DOWNLOAD DATA

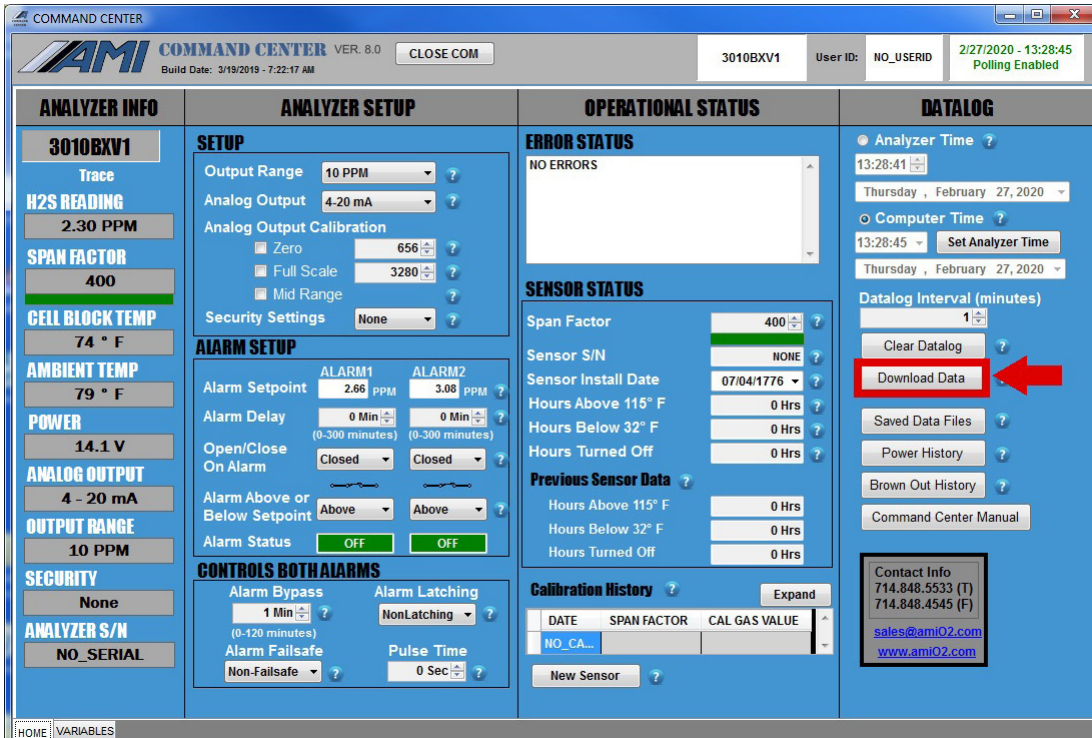

To begin, click the DOWNLOAD DATA Button located on the **COMMAND CENTER** User Interface.

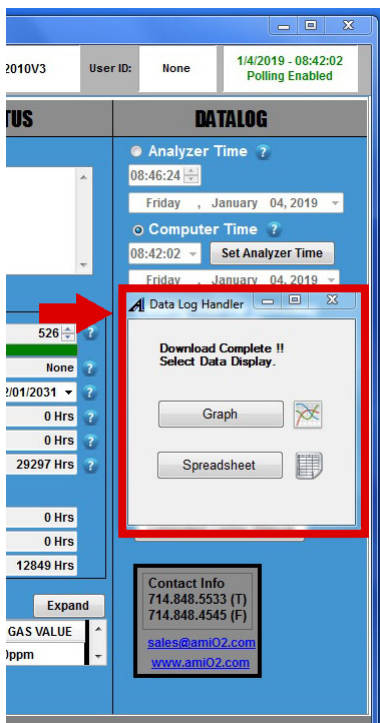

A DATALOG HANDLER window will appear, giving you the options of seeing your downloaded data as either a graph or spreadsheet.

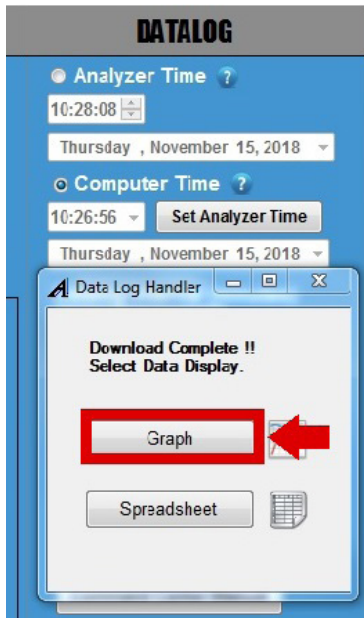

To see the graph, click the GRAPH Button.

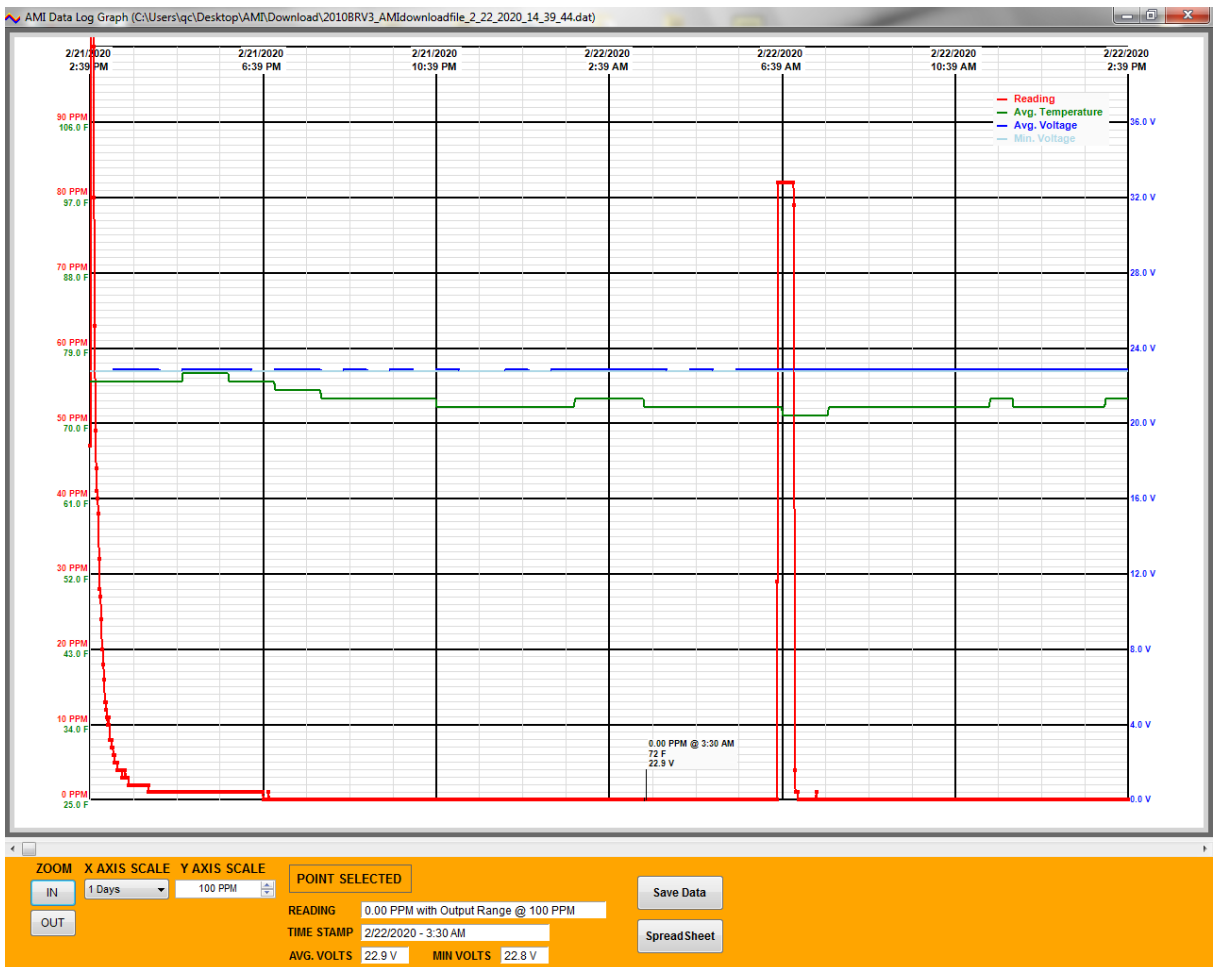

(Sample Graph of Downloaded Data)

You can save your graph to a file by clicking the SAVE DATA Button.

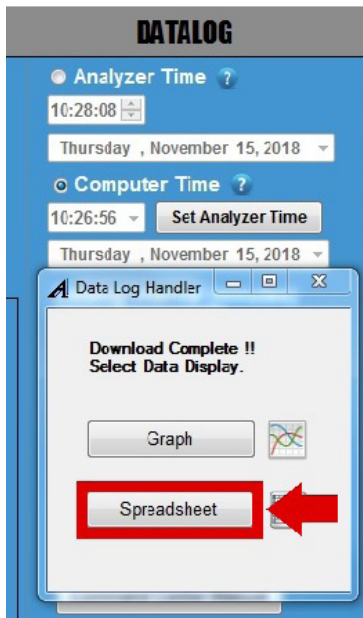

To see your downloaded data as a spreadsheet instead, click the SPREADSHEET Button. on the DATALOG HANDLER Window.

Date	Time	Output Range	Log Period	Output Reading	Avg. Voltage	Min Voltage	Avg. Temp.
8/09/2018	04:44:13	420 PPM	1 min	302 PPM	11.9 V	11.8 V	81 F
8/09/2018	04:45:13	420 PPM	1 min	290 PPM	11.9 V	11.8 V	81 F
8/09/2018	04:46:13	420 PPM	1 min	277 PPM	11.9 V	11.8 V	81 F
8/09/2018	04:47:13	420 PPM	1 min	286 PPM	11.9 V	11.8 V	81 F
8/09/2018	04:48:13	420 PPM	1 min	294 PPM	11.9 V	11.8 V	81 F
8/09/2018	04:49:13	420 PPM	1 min	286 PPM	11.9 V	11.8 V	81 F
8/09/2018	04:50:13	420 PPM	1 min	277 PPM	11.9 V	11.8 V	81 F
8/09/2018	04:51:13	420 PPM	1 min	294 PPM	11.9 V	11.8 V	81 F
8/09/2018	04:52:13	420 PPM	1 min	302 PPM	11.9 V	11.8 V	81 F
8/09/2018	04:53:13	420 PPM	1 min	302 PPM	11.9 V	11.8 V	81 F
8/09/2018	04:54:13	420 PPM	1 min	302 PPM	11.9 V	11.8 V	81 F
8/09/2018	04:55:13	420 PPM	1 min	302 PPM	11.9 V	11.8 V	81 F
8/09/2018	04:56:13	420 PPM	1 min	302 PPM	11.9 V	11.8 V	81 F
8/09/2018	04:57:13	420 PPM	1 min	302 PPM	11.9 V	11.8 V	81 F
8/09/2018	04:58:13	420 PPM	1 min	302 PPM	11.9 V	11.8 V	81 F
8/09/2018	04:59:13	420 PPM	1 min	302 PPM	11.9 V	11.8 V	81 F
8/09/2018	05:00:13	420 PPM	1 min	302 PPM	11.9 V	11.8 V	81 F
8/09/2018	05:01:13	420 PPM	1 min	302 PPM	11.9 V	11.8 V	81 F
8/09/2018	05:02:13	420 PPM	1 min	302 PPM	11.9 V	11.8 V	81 F
8/09/2018	05:03:13	420 PPM	1 min	302 PPM	11.9 V	11.8 V	81 F
8/09/2018	05:04:13	420 PPM	1 min	302 PPM	11.9 V	11.8 V	81 F
8/09/2018	05:05:13	420 PPM	1 min	302 PPM	11.9 V	11.8 V	81 F
8/09/2018	05:06:13	420 PPM	1 min	302 PPM	11.9 V	11.8 V	81 F
8/09/2018	05:07:13	420 PPM	1 min	302 PPM	11.9 V	11.8 V	81 F
8/09/2018	05:08:13	420 PPM	1 min	302 PPM	11.9 V	11.8 V	81 F

(Sample Spreadsheet of Downloaded Data)

You can save your spreadsheet to a file by clicking the SAVE DATA Button.

END OF DATA DOWNLOAD

MODBUS RTU Protocol over RS485 Communications

The Modbus address is entered in variable N1 for the Analyzer.

Directions for Writing to this Variable

- Open the COMMAND CENTER and initiate communication with the Analyzer
- When the COMMAND CENTER communicates with the Analyzer, go to the VARIABLES Page of the COMMAND CENTER
- Go to the User Input of the Variable Page. Click on the USER INPUT and enter 'AMI' for the password when prompted. Then, return to the USER INPUT
- In the USER INPUT, enter the following to change the address of the Modbus:

AOWN1<Address>, where <Address> is 1-255

Note: By default, it is set to 17.

Using the Modbus RTU command, you can read the Analyzer's Modbus register(s):

(Note: There are a total of eight bytes to send)

- Byte 0 = Address (Modbus Bus Slave addressed to be entered into variable N1)
- Byte 1 = 3
- Byte 2 = 0
- Byte 3 = Register (Register equals the Starting Register for the Modbus read)
- Byte 4 = 0
- Byte 5 = Count (Count equals the Number of Registers to be read)
- Byte 6 = CRC Bytes
- Byte 7 = CRC Bytes

Table I: Holding Registers for MODEL 2010BX, 210BX, and 3010BX

Register	Number of Register	Variable	Description	Type
0	16	A0RA0	Reading	String
16	1	A0RA1	PPMX10 (Upper 16bits)	Unsigned 16 Bit
17	1	A0RA2	PPMX10 (Lower 16bits)	Unsigned 16 Bit
18	1	A0RA3	PERCENTX100	Unsigned 16 Bit
19	8	A0RA6	Override Temp Coef C2	String
27	8	A0RA7	Override Temp Coef C1	String
35	8	A0RA8	Override Temp Coef C0	String
43	8	A0RA9	Override Temp Coef Word	String
51	1	A0RB0	Output Range Index	Unsigned 16 Bit
52	8	A0RC0	Software version	String
60	1	A0RC2	Cycle Count	Unsigned 16 Bit
61	1	A0RD0	Span Factor	Unsigned 16 Bit
62	1	A0RE3	Output Zero Offset	Unsigned 16 Bit
63	1	A0RE4	Output Span	Unsigned 16 Bit
64	1	A0RE5	Heater Control	Unsigned 16 Bit
65	1	A0RE6	Analyzer Setting Configuration	Unsigned 16 Bit
66	1	A0RF0	Alarm 1 Setpoint	Unsigned 16 Bit
67	1	A0RG0	Alarm 2 Setpoint	Unsigned 16 Bit
68	1	A0RH0	Alarm State	Unsigned 16 Bit
69	1	A0RH1	Alarm Config 2	Unsigned 16 Bit
70	1	A0RI0	Error Register 0	Unsigned 16 Bit
71	1	A0RI1	Error Register 1	Unsigned 16 Bit
72	1	A0RI2	Error Register 2	Unsigned 16 Bit
73	1	A0RI3	Error Register 3	Unsigned 16 Bit
74	8	A0RJ0	Analyzer Type	String
82	1	A0RJ1	Heater, AC Configuration	Unsigned 16 Bit
83	16	A0RK0	Latest Calibration Data	String
99	8	A0RL0	Serial Number	String
107	8	A0RL1	Tracking Number	String
115	8	A0RL2	User ID	String
123	10	A0RM0	Latest Start-up Info	String
133	2	A0RN0	Analyzer COM ID	String
135	1	A0RN1	Modbus ID	Unsigned 16 Bit
136	10	A0RO0	Latest Low Power Event	String
146	1	A0RP0	Seconds	Unsigned 16 Bit
147	1	A0RP1	Minutes	Unsigned 16 Bit
148	1	A0RP2	Hours	Unsigned 16 Bit
149	1	A0RP3	DOW	Unsigned 16 Bit

Table I: Holding Registers for MODEL 2010BX, 210BX, and 3010BX (continued)

Register	Number of Register	Variable	Description	Type
150	1	A0RP4	DOM	Unsigned 16 Bit
151	1	A0RP5	Month	Unsigned 16 Bit
152	1	A0RP6	Year	Unsigned 16 Bit
153	1	A0RP7	Log Interval	Unsigned 16 Bit
154	1	A0RT0	Block Temperature	Unsigned 16 Bit
155	1	A0RT1	Power Section Temperature	Unsigned 16 Bit
156	8	A0RT2	Actual Pressure	String
164	1	A0RT3	Power Voltage	Unsigned 16 Bit
165	1	A0RT4	Heater Feedback Voltage	Unsigned 16 Bit
166	1	A0RT5	Ambient Pressure	Unsigned 16 Bit
167	1	A0RT6	Absolute Pressure	Unsigned 16 Bit
168	1	A0RU0	Sensor Hours of Operation	Unsigned 16 Bit
169	1	A0RU1	Sensor PPM Hours Average	Unsigned 16 Bit
170	1	A0RU2	Sensor Hours Hot	Unsigned 16 Bit
171	1	A0RU3	Sensor Hours Cold	Unsigned 16 Bit
172	1	A0RU4	Sensor Hours Off	Unsigned 16 Bit
173	1	A0RU5	Last Sensor Hours of Operation	Unsigned 16 Bit
174	1	A0RU6	Last Sensor PPM Hours Average	Unsigned 16 Bit
175	1	A0RU7	Last Sensor Hours Hot	Unsigned 16 Bit
176	1	A0RU8	Last Sensor Hours Cold	Unsigned 16 Bit
177	1	A0RU9	Last Sensor Hours Off	Unsigned 16 Bit
178	8	A0RV0	Sensor Date of Last Reset	String
186	8	A0RV1	Sensor Serial Number	String
194	1	A0RW0	Alarm Pulse Time	Unsigned 16 Bit
195	1	A0RX0	Delay on for Alarm 1	Unsigned 16 Bit
196	1	A0RY0	Delay on for Alarm 2	Unsigned 16 Bit
197	1	A0RZ0	Alarm Hold-off Time	Unsigned 16 Bit

Table II: Coils

Coil	Name	Meaning if Set (1)	Meaning if Reset (0)
24	Allow writing into Analyzer	Enables writing	Disables writing

Table III: Diagnostic Functions

The diagnostic functions 0, 1, 2, 4, 10, 11, 12, 13, 14, 15, and 16 are supported.

Note that each counter will count up to 65535 but will not go any higher. They can be reset to zero with the 10 command.

Function	Command (without CRC)	Action	Notes
0	11 08 00 00	Echo Message	Return the Exact Same Message
1	11 08 00 01	Restart Communication	Restarts from a Previous 4 Command
2	11 08 00 02	Return Error Byte	Returns Same as Holding Register 23
4	11 08 00 04	Listen Only Mode	Stops the Analyzer from Responding to Anything
10	11 08 00 0A	Clear All Diagnostic Counters	Clear Each of the Diagnostic Counters to Zero
11	11 08 00 0B	Total Message Count	Total Number of Messages Seen by the Analyzer
12	11 08 00 0C	CRC Error Count	Number of CRC Errors Seen by the Analyzer
13	11 08 00 0D	Exception Count	Number of Invalid Modbus Commands
14	11 08 00 0E	Number of Slave Messages	Number of Messages the Analyzer has Returned
15	11 08 00 0F	Number of No Responses	Number of Messages Addressed to the Analyzer that It did not Respond to
16	11 08 00 10	Number of NAK Responses	Number of Messages with Incorrect Parameters (such as Invalid Registers or Out-of-bounds Values) Seen by the Analyzer

END OF MODBUS 485 COMMUNICATIONS PROTOCOL

TROUBLESHOOTING, MAINTENANCE & REPAIRS

The following section identifies potential system issues and provides possible resolutions. If you are unable to resolve an issue after following the suggestion(s) shown in this section, contact AMI for further support.

Error Status Display: Error Reference Guide

The following section shows the existing error(s) that can be detected by the Analyzer. Each error has an assigned number and message.

Error Number	Message
0	
1	
2	
3	
4	
5	
6	Power Supply Too Low
7	PPM Over Range
8	
9	
10	
11	
12	Over / Under Pressure
13	
14	Over / Under Temperature
15	
16	
17	Memory Failures
18	
19	Analytical Timeout
20	Analytical Warm-up
21	
22	Output Range Index Wrong
23	No Sensor Current
24	Span Too Low
25	Span Too High
26	
27	Percent Over Range
28	No Heater Feedback
29	Ambient and Cell Block Temperature Conflict
30	Heater Voltage Too High
31	
32	
33	
34	
35	
36	ADC Timeout
37	
38	
39	

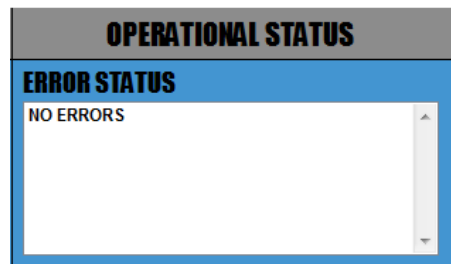

Note:

All error codes can be displayed on the Error Status Display. Once troubleshooting is completed and the error is resolved, the message will automatically be removed from the Error Status Display by the Analyzer.



Note:

The LCD of the Analyzer will display 'fail-safe' error code(s).

If a 'fail-safe' error code is detected, the 'error number' and 'ERR' will display and blink on the LCD (as indicated above).

Once the troubleshooting is completed and the error is resolved, the error code will no longer display.

TROUBLESHOOTING

Analyzer Does Not Power Up

Resolution(s):

- Check that the power is connected properly and you have the correct version for your power supply
 - Check that the power supply voltage is between 10V and 24VDC or 100V to 240VAC
 - Verify that the power plug is seated fully in its socket all the way and no whiskers or wires are shorting to each other or to the cover
-

Analyzer Reads Too Low

Resolution(s):

- If the SPAN FACTOR is currently too high for adjustment, replace the H₂S sensor
 - Calibrate with Span Gas (refer to pages 22 – 23)
-

Analyzer Reads Too High

Resolution(s):

- Leak test all external fittings. We recommend using SNOOP® (see page 19)
 - Check that the gas flow rate is between 1.0 to 2.0 SCFH
-

Analyzer Reads Zero

Resolution(s):

- Hook up a tank of Span Gas and confirm the Analyzer responds upscale accurately.
-

No Voltage or Current Output to Recording Device

Resolution(s):

- Check that the output wires are properly stripped and connected at their correct positions at their respective terminals
-

Analyzer Refuses to Accept Front Panel Settings

Resolution(s):

- Use the **COMMAND CENTER Software** to verify that the Security Settings match your preference
-

No Output Alarm Indication

Resolution(s):

- Verify that the alarm and alarm delay setpoints are correct
 - Confirm the Alarm Delay or Alarm Hold Off setting is correct
 - Check that the output wires are properly stripped and connected at their correct positions at their respective terminals
 - Verify that the alarms on the Analyzer are properly configured using the **COMMAND CENTER Software** (see pages 32 – 35)
-

'Err' Flashes on the LCD

Resolution(s):

- Look up the Error Code on page 44 and troubleshoot/resolve it
 - If you cannot resolve, contact AMI for further support
-

Display Pressure Reading Not Correct

Resolution(s):

- Perform the Initiation of the Pressure Sensor Procedure on page 15
-

MAINTENANCE

Sensor Replacement

It is recommended that the sensor be replaced when the Span Factor exceeds a value of 980.

Action:

- Refer to page 21 for instructions on how to replace the sensor
 - Refer to page 23 for instructions on how to view the Span Factor
-

Analyzer Calibration

For the best accuracy, it is recommended that the Analyzer is calibrated every 30 to 45 days.

Action:

- Refer to pages 22 to 23 for instructions on how to perform a calibration
-

Sealing/Ingress Protection Maintenance

Whenever the Adalet Explosion-proof cap is opened, visually inspect the O-ring for any signs of damage or excessive wear.

Action:

- If the O-ring needs to be replaced, contact AMI
-

IMPORTANT MESSAGE ABOUT REPAIRS

Where repair is possible:



SUBSTITUTION OF COMPONENTS MAY IMPAIR INTRINSIC SAFETY.

LE REMPLACEMENT DE COMPOSANTS PEUT COMPROMETTRE LA SECURITE INTRINSEQUE.

IMPORTANT MESSAGE ABOUT CLEANING REQUIREMENTS

The Analyzer is designed to function properly without cleaning requirements.

For any other issue not covered in this section, contact AMI at 714.848.5533 or visit us at www.amio2.com for support.

END OF TROUBLE SHOOTING, MAINTENANCE & REPAIRS

SPECIFICATIONS

USAGE

Both indoor and outdoor use
Altitude for Use _____ $\leq 2,500$ meters for AC model and $\leq 5,500$ meters for DC model
Relative Humidity _____ $< 95\%$, non-condensing
Ingress Protection _____ IP65

PHYSICAL

Dimensions _____ 13.3"W x 10.0"H x 5.1"D (33.8 cm x 25.4 cm x 13.0 cm)
Weight _____ 16.0 lbs (7.26 kg)
Digital Display _____ 4-digit LCD (reads full scale from 0.00 ppm to 25.0%)
Mounting _____ Wall mount or 2.0" pipe
Gas Connections _____ $\frac{1}{4}$ " 316 S.S. compression fittings
Wetted Parts _____ 316 S.S. fittings, electro-less nickel-plated cell block, gold-plated contacts, acrylic-flow meter & Vitron O-rings
Materials _____ Case (painted aluminum, Door Seal (urethane foam), Window (plastic), O-ring (neoprene)

TECHNOLOGY

Method of Measurement _____ Electrochemical Sensor
Key Technologies _____

ELIMINATOR CELL BLOCK™,
COMMAND CENTER Interface Software

(which includes the following:
Datalogger, Error Status Display, Brown-out History,
Power-up History, USB Virtual Comport, Modbus RS485
and Modbus TCP/IP)

PERFORMANCE

Low Minimum Detection Threshold _____ 0.05 ppm of H₂S
Response Time _____ 90% full scale response times for these specified ranges:
< 120 sec for 0 – 100 ppm @ 1.5SCFH
< 120 sec for 0 – 2000 ppm @ 1.5SCFH
Response to Methyl Mercaptan _____ 40% of actual concentration
Response to Sulfur Dioxide _____ 18% of actual concentration
Repeatability _____ $\pm 1\%$ of range or ± 0.2 ppm of H₂S, whichever is greater
Diurnal Temperature Specification _____ $< \pm 2\%$ of scale over temperature range
Data Collection Capacity _____ 15 days of data recording @ 1 datapoint per minute
Inlet Gas Pressure _____ 0.5 – 150 psig (0.03 – 10.3 bar)
Protection _____ RFI-protected

OPERATION

Analog Output Ranges _____ 4 user selectable ranges (0–10 ppm, 0–50 ppm, 0–100 ppm, 0–200 ppm),
optional output ranges (0–100 ppm, 0–500 ppm, 0–1000 ppm, 0–2000 ppm)
Operating Temperature Range _____ non-heated: 25°F to 115°F (-3.9°C to 46°C),
heated: -20°F to 115°F (-29°C to 46°C),
with **Extreme Weather Enclosure**: -40°F to 115°F (-40°C to 46°C)
Recommended Flow Rate _____ 1.0 to 2.0 SCFH
Isolated Analog Output Signals _____ 1–5 VDC and 4–20 mA

ALARMS

Number of Alarms _____ 2 Fully, Adjustable H₂S Concentration Alarms with Dry Contacts
Alarm Delays _____ Programmable from 0 – 300 minutes
Alarm Hold-off / Bypass _____ Programmable from 0 – 120 minutes
Alarm Relay Contact Rating _____ 5A@115VAC or 24VDC

AREA CLASSIFICATION

Area Classification _____

US/Canada:

Class I, Division 1, Groups B,C,D, T4

Class I Zone 0/1, AEx ia/db IIB+H2 T4 Ga/Gb

Ex ia/db IIB+H2 T4 Ga/Gb

$-32^{\circ}\text{C} \leq T_{\text{amb}} \leq +46^{\circ}\text{C}$

IECEX:

Ex ia IIB+H2 T4 Ga/Ex db IIB +H2 T4 Gb

$-32^{\circ}\text{C} \leq T_{\text{amb}} \leq +46^{\circ}\text{C}$

ATEX:

 II 1/2 G Ex ia/db IIB+H2 T4 Ga/Gb

$-32^{\circ}\text{C} \leq T_{\text{amb}} \leq +46^{\circ}\text{C}$

A:

Ex ia/db IIB+H2 T4 Ga/Gb

$-32^{\circ}\text{C} \leq T_{\text{amb}} \leq +46^{\circ}\text{C}$

POWER

Requirements _____

10 – 24 VDC, U_m 24 VDC, 150 mA max (non-heated)

10 – 24 VDC, U_m 24 VDC, 2.2 Amps max (heated)

100 – 240 VAC, U_m 240 VAC, 150 mA max (non-heated)

100 – 240 VAC, U_m 240 VAC, 550 mA max (heated)

Use only approved Class 2 or limited energy circuits

AMI[®] WARRANTY & SUPPORT

LIMITED WARRANTY/DISCLAIMER

The warranty period is **TWO YEARS** for the Analyzer. Any failure of material or workmanship will be repaired free of charge for that specified period from the original purchase (shipping date) of the instrument. AMI will also pay for 1-way ground shipment back to the customer.

The warranty period for the electrochemical oxygen sensor is 6 months.

The warranty period for the electrochemical H₂S sensor is 6 months.

The warranty period for the zirconium oxide sensor is 2 years.

Any indication of abuse or tampering of the instrument will void the warranty.

Receiving the Analyzer

When you receive the instrument, check the package for evidence of damage and if any is found contact the shipper. Although every effort has been made to assure that the Analyzer meets all performance specifications, AMI takes no responsibility for any losses incurred by reason of the failure of this analyzer or associated components. AMI's obligation is expressly limited to the Analyzer itself.

EXCEPT FOR THE FOREGOING LIMITED WARRANTY, AMI MAKES NO WARRANTIES, EXPRESS, IMPLIED OR STATUTORY, AS TO THE NON-INFRINGEMENT OF THIRD-PARTY RIGHTS, MERCHANTABILITY, OR FITNESS FOR A PARTICULAR PURPOSE. IF APPLICABLE LAW REQUIRES ANY WARRANTIES WITH RESPECT TO THE SYSTEM, ALL SUCH WARRANTIES ARE LIMITED IN DURATION TO TWO (2) YEARS FROM THE DATE OF DELIVERY.

LIMITATION OF LIABILITY

IN NO EVENT WILL AMI BE LIABLE TO YOU FOR ANY SPECIAL DAMAGES, INCLUDING ANY LOST PROFITS, LOST SAVINGS, OR OTHER INCIDENTAL OR CONSEQUENTIAL DAMAGES, EVEN IF THE COMPANY HAS BEEN ADVISED OF THE POSSIBILITY OF SUCH DAMAGES, OR FOR ANY CLAIM BY ANY OTHER PARTY.

LIMITATION OF REMEDIES

AMI's entire liability and your exclusive remedy under the Limited Warranty (see above) shall be the replacement of any Analyzer that is returned to the Company and does not meet the Company's Limited Warranty.



Instrument Expert
Original factory packaging
www.keruiyiqi.cn



HIGH PERFORMANCE

RELIABILITY

INTUITIVE DESIGN

www.amio2.com

Tel 714.848.5533
Fax 714.848.4545

OM-300-035 Rev J
10/31/2023

© Advanced Micro Instruments, Inc.

ADDRESS:

Advanced Micro Instruments, Inc.
225 Paularino Avenue
Costa Mesa, CA 92626

